

> recirculation line

# multi

800 - 1300 - 2500 - 4000 - 5800

**multi** : multifunction pump  
for water recirculation



- multi** > Multifunktionelle umwaelzpumpe des wassers
- multi** > Pompe multifonctions pour la circulation de l'eau
- multi** > Bomba multifunción para la recirculación del agua
- multi** > Pompa multifunzione per il ricircolo dell'acqua



 **SICCE**  
Technology for water applications

pump program ●



Thanks to the NRG System  
no mechanical parts  
for controlling the impeller  
direction are required.

PATENTED

# multi

Ceramic  
shaft

(except  
mod. 800-1300)



NRG  
powered

(except  
mod. 800-1300)

Threaded  
intake/discharge

(except mod. 800)

Strong  
case



Wet & Dry  
Application

(except mod. 800)



AQUARIUM



FOUNTAIN



POND



Technology for water applications

**GB** From the 800 lt/h model to the powerful 5800 lt/h model, the Multi line comprises five recirculating pumps for every type of pond up to 10,000 litres. Built according to the strictest international safety regulations, they operate in Wet & Dry mode (except the 800 model), are easy to maintain and are surprising for their high performance and reliability. The 2500-4000-5800 models of the Multi line may be combined with the Eco Max internal filter for ponds or associated with a sponge pre-chamber in order to create waterfalls and pleasant water effects in the pond.

**D** Vom Modell 800 l/h bis zum leistungsstarken Modell 5800 l/h umfasst die Linie Multi fünf Umwälzpumpen für jede Art von Gartenteich bis zu 10.000 Liter. Diese Pumpen, die nach den strengsten internationalen Sicherheitsnormen konstruiert wurden, arbeiten im Betriebsmodus Wet & Dry (ausgenommen Modell 800), sind einfach zu warten und überraschen durch ihre hohen Leistungen und ihre Zuverlässigkeit. Die Produktlinie Multi kann bei den Modellen 2500-4000-5800 mit dem Innenfilter für Gartenteiche Eco Max kombiniert oder mit einer Schwamm-Vorkammer zur Erzeugung von Wasserfällen und reizvollen Wasserspielen im Teich verbunden werden.

**F** Du modèle 800 au puissant modèle 5800, la ligne Multi comprend cinq pompes de circulation pour tous les types d'aquariums, fontaines ou bassins. Construites selon les normes internationales de sécurité les plus sévères, elles fonctionnent en mode Wet & Dry (à l'exclusion du modèle 800), sont faciles à entretenir et surprennent par leurs hautes performances et leur fiabilité. Les modèles 2500-4000-5800 peuvent être associés au filtre interne pour bassins Eco Max ou à une préchambre éponge pour créer des cascades et des jeux d'eau suggestifs dans le bassin.



## NRG SYSTEM SICCE

The NRG system is a revolution in the sector of permanent magnet synchronous motors and allows you to obtain exceptional power, reduced consumption, great reliability and very low noise levels.

Das System NRG stellt eine Revolution auf dem Sektor der Synchronmotoren mit Permanentmagnet dar und ermöglicht es, außergewöhnliche Leistungen, verminderten Verbrauch, hohe Zuverlässigkeit und die niedrigsten Geräuschpegel zu erzielen.

Le système NRG est une révolution dans le secteur des moteurs synchrones à aimant permanent et permet d'obtenir des puissances exceptionnelles, des consommations réduites, une grande fiabilité et un fonctionnement très silencieux.

Con el sistema NRG, revolucionario en el sector de motores síncronos de magneto permanente, se consiguen potencias excepcionales, consumos reducidos, gran fiabilidad y niveles de ruido sumamente bajos.

Il sistema NRG è una rivoluzione nel settore dei motori sincroni a magnete permanente e consente di ottenere potenze eccezionali, ridotti consumi, grande affidabilità ed i più bassi livelli di rumorosità.



## WET AND DRY APPLICATION

The WET & DRY application permits the models of the MULTI (except the smallest mod. 800) to be utilized whether they are completely submerged or outside of the water. When operating out of the water, the pump does not overheat as a result of the research during the designing of the surfaces and materials. The static seals do not present any problems of water loss and in the case of impeller blockage or malfunction, a reversible thermal protector stops the flow of current to the motor, preventing any possible damage of the pump.

Die Anwendung WET & DRY ermöglicht den Einsatz der Modelle der Produktlinie Multi (außer beim kleinsten Modell 800) sowohl in vollständig eingetauchtem Zustand als auch außerhalb des Wassers. Außerhalb des Wassers überhitzt sich die Pumpe nicht, dank der speziellen Ausarbeitung der Oberflächen und der Materialien während der Planungsphase. Dank der statischen Dichtungen weist die Pumpe keinerlei Probleme von Wasseraustritt auf, und im Fall eines Defekts oder einer Funktionsstörung unterbricht ein reversibler Thermoerschutz die Stromversorgung und verhindert jegliche Beschädigung der Pumpe.

L'application WET & DRY permet d'employer les modèles de la ligne Multi (sauf le plus mod. 800) soit complètement immergés soit hors de l'eau. Hors de l'eau, la pompe ne se surchauffe pas grâce à l'étude en phase de projet des surfaces et des matériaux. Grâce aux garnitures d'étanchéités fixes, la pompe ne présente aucun problème de fuite d'eau et en cas de panne ou de mauvais fonctionnement un relais de protection thermique réversible interrompt l'alimentation, en évitant tout dommage à la pompe.

La aplicación WET & DRY permite utilizar los modelos de la línea Multi (excepto el más pequeño, el mod. 800) tanto fuera del agua como completamente sumergidos. La bomba no se sobrecalienta fuera del agua pues en la fase del proyecto se realizaron estudios tanto de sus superficies como de los materiales. Gracias a las estanqueidades estáticas, la bomba no presenta ningún problema de fuga de agua y, en el caso de avería o de malfuncionamiento, un protector térmico reversible interrumpe la alimentación impidiendo que la bomba se estropee.

L'applicazione WET & DRY permette di impiegare i modelli della linea multi (eccetto il più piccolo mod. 800) sia completamente immersa sia fuori dall'acqua. Fuori dall'acqua la pompa non si surriscalda grazie allo studio in fase di progettazione delle superfici e dei materiali. Grazie alle tenute statiche la pompa non presenta nessun problema di perdita d'acqua e nel caso di guasto o malfunzionamento un protettore termico reversibile interrompe l'alimentazione, impedendo qualsiasi danneggiamento della pompa.



## AIR MIX SYSTEM

The pre-chamber accessory with Air Mix system available for 2500, 4000, 5800 models (optional) allows large quantities of air to be mixed with the water, considerably increasing the concentration of Oxygen (O<sub>2</sub>).

Das für die Modelle 2500, 4000, 5800 lieferbare Vorkammer-Zubehörteil mit System Air Mix ermöglicht das Vermischen großer Luftmengen mit Wasser, wodurch dessen Sauerstoffkonzentration (O<sub>2</sub>) spürbar erhöht wird.

L'accessoire préchambre avec système Air Mix disponible pour les modèles 2500, 4000, 5800 (optional) permet de mélanger de grandes quantités d'air à l'eau, en augmentant sensiblement la concentration d'oxygène (O<sub>2</sub>).

Gracias al accesorio precámara con sistema Air Mix disponible en los modelos 2500, 4000 y 5800 (optional), es posible mezclar grandes cantidades de aire y agua, con lo que se aumenta la concentración de oxígeno (O<sub>2</sub>) de forma considerable.

L'accessorio precamera con sistema Air Mix disponibile per i modelli 2500, 4000, 5800 (optional) consente di miscelare grandi quantità di aria con l'acqua, aumentando sensibilmente la concentrazione di Ossigeno (O<sub>2</sub>).



Multi 5800 with Air Mix System (optional)



**E** Del modelo 800 al potente modelo 5800, la línea Multi comprende cinco bombas de recirculación para cada tipo de acuario, fuente o estanque. Fabricadas con arreglo a las más estrictas normas internacionales de seguridad, funcionan con modalidad Wet & Dry (a excepción del mod. 800). Su mantenimiento es fácil y sorprenden por sus extraordinarias prestaciones y fiabilidad. Los modelos 2500-4000-5800 se pueden acoplar al filtro interior para estanques Eco Max o asociar a una precámara de esponja para crear cascadas y sugestivos juegos de agua en los estanques.

**I** Dal modello 800 al potente modello 5800 la linea Multi comprende cinque pompe da ricircolo per ogni tipo di acquario, fontana o laghetto. Costruite secondo le più severe norme internazionali di sicurezza, funzionano in modalità Wet & Dry (escluso mod. 800), sono di facile manutenzione e sorprendono per le elevate prestazioni ed affidabilità. I modelli 2500-4000-5800 possono essere abbinati al filtro interno per laghetti Eco Max o associati ad una precamera spugna per creare cascate e suggestivi giochi d'acqua all'interno di un laghetto.





# multi

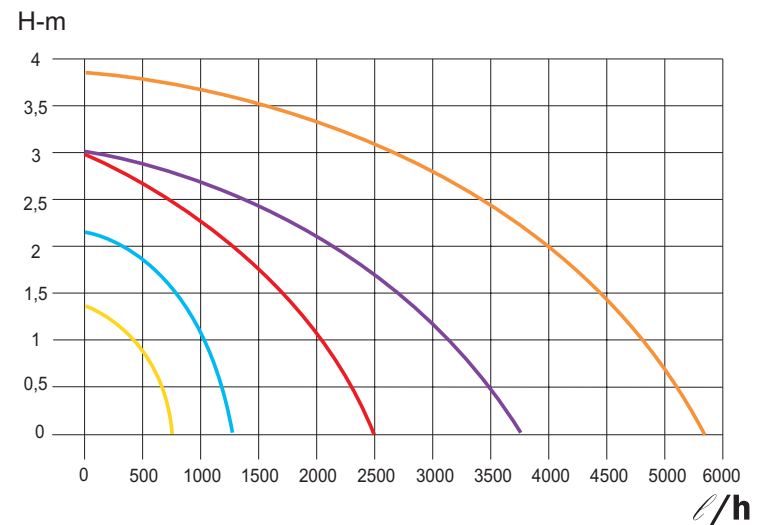



**MULTI 800**  
1,5 m cable



**MULTI 800**  
10 m cable



**MULTI 1300**  
1,5 m cable



**MULTI 1300**  
10 m cable



**MULTI 2500 - 4000**  
1,5 m cable



**MULTI 2500 - 4000**  
10 m cable



**MULTI 5800**  
1,5 - 10 m cable

FLOW REGULATOR INCLUDED

Included



HOSE CONNECTOR



HOSE CONNECTOR  
AND SPONGE



HOSE CONNECTOR



HOSE CONNECTOR



HOSE CONNECTOR



HOSE CONNECTOR



HOSE CONNECTOR

Optional



LONG PRECHAMBER



LONG PRECHAMBER



LONG PRECHAMBER  
AIR MIX PRECHAMBER



AIR MIX PRECHAMBER



AIR MIX PRECHAMBER

Packaging

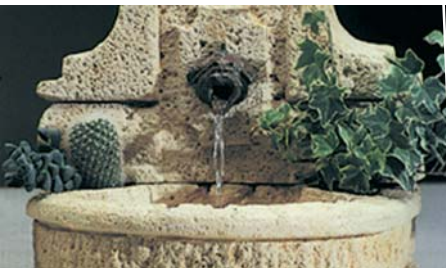

Packaging  
dimensions



	Length	Depth	Height
Multi 800-1300 1,5 m cable	125 mm	122 mm	100 mm
Multi 800-1300 10 m cable	188 mm	120 mm	200 mm
Multi 2500-4000 1,5 m cable	188 mm	120 mm	150 mm
Multi 5800 1,5 m cable	188 mm	120 mm	150 mm
Multi 2500-4000-5800 10 m cable	188 mm	120 mm	150 mm



# multi

Aquarium application



Fountain application

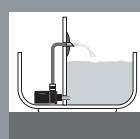

Pond application



Multi	800	1300	2500	4000	5800
Tank capacity	60 - 200 l	150 - 300 l	200 - 600 l	400 - 1000 l	700 - 1400 l
Fountain height	0,4 - 1 m	0,6 - 1,5 m	1 - 2,5 m	1 - 2,5 m	1,5 - 3 m
Max pond size	1000 L	2000 L	3000 L	5000 L	8000 L

Multi_800		Multi_1300		Multi_2500		Multi_4000		Multi_5800	
Volt 230 ~	Volt 120 ~	Volt 230 ~	Volt 120 ~	Volt 230 ~	Volt 120 ~	Volt 230 ~	Volt 120 ~	Volt 230 ~	Volt 120 ~
Hz 50	Hz 60	Hz 50	Hz 60	Hz 50	Hz 60	Hz 50	Hz 60	Hz 50	Hz 60
Watt 13	Watt 13	Watt 20	Watt 25	Watt 55	Watt 40	Watt 67	Watt 48	Watt 90	Watt 142
A 0,1	A 0,2	A 0,2	A 0,4	A 0,51	A 0,5	A 0,64	A 0,8	A 0,8	A 2,9
H-m 1.30	Feet 4.4	H-m 1.70	Feet 6.0	H-m 3.10	Feet 10.5	H-m 3.10	Feet 10.5	H-m 3.80	Feet 12
l/h 800	gph 220	l/h 1200	gph 320	l/h 2500	gph 715	l/h 3800	gph 990	l/h 5800	gph 1500

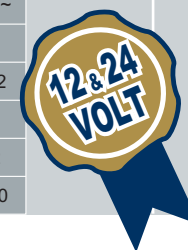

Models available in low voltage please contact us for specifications.

**SICCE**  
Technology for water applications



Also for  
pool and spa  
applications

## multi 800

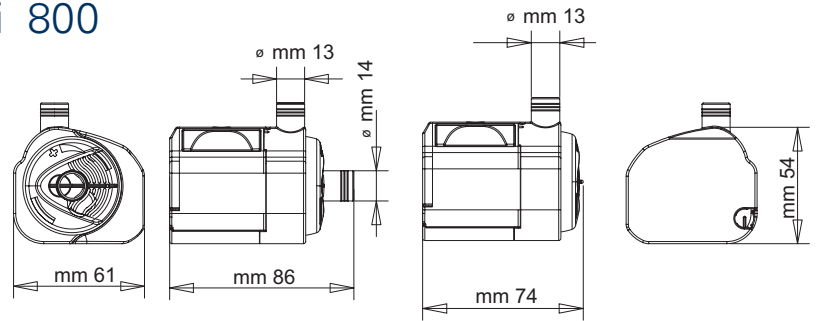

## multi 1300

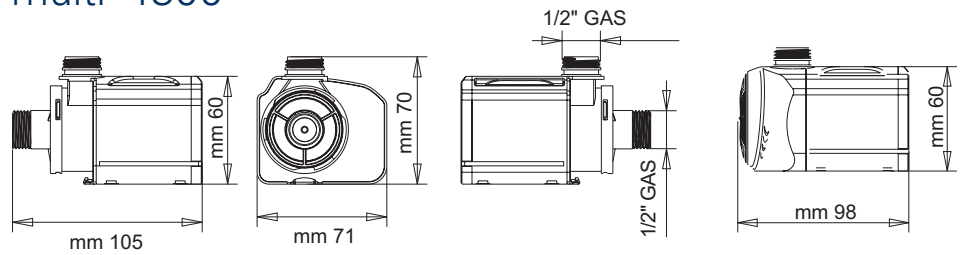



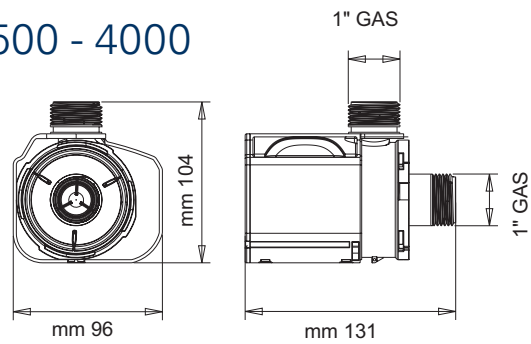



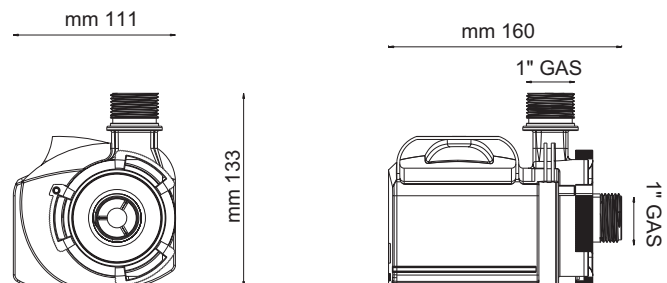





















## multi 2500 - 4000



## multi 5800



MULTI	APPLICATION	PLUS
800	 	
1300	  	 
2500	  	   
4000	  	   
5800	  	   



Aquarium application



Pebble application













Fountain application



Pond application

## ■ Accessory - Spare parts

Multi		800	1300	2500	4000	5800
<b>Spare Parts</b>						
<b>ROTOR</b>		<b>90209</b> (230-240V) <b>SGR0002</b> (120V)	<b>SGR0003</b> (230-240V) <b>SGR0004</b> (120V)	<b>SGR0005</b> (230-240V) <b>SGR0006</b> (120V)	<b>SGR0005</b> (230-240V) <b>SGR0006</b> (120V)	<b>SGR0008</b> (230-240V) <b>SGR0009</b> (120V)
<b>CERAMIC SHAFT</b>				<b>SGR0007</b>	<b>SGR0007</b>	<b>SGR0010</b>
<b>SPONGE</b>		<b>SSP0003</b>				
<b>O-Rings</b>		<b>SKT0019</b>	<b>SKT0020</b>	<b>SKT0021</b>	<b>SKT0021</b>	<b>SKT0022</b>
<b>HOSE CONNECTOR</b>		<b>SPL0004</b>	<b>STR0001</b>	<b>STR0002</b>	<b>STR0002</b>	<b>STR0003</b>
<b>Accessory</b>						
<b>PRECHAMBER with flow regulator</b>		<b>SPL0003</b>	<b>SPL0007</b>			
<b>LONG PRECHAMBER</b>		<b>SPL0005</b> (+ sponge)	<b>SPL0006</b>	<b>SPL0008</b>	<b>SPL0010</b>	<b>SPL0012</b>
<b>FLAT PRECHAMBER</b>				<b>SPL0009</b>	<b>SPL0011</b>	
<b>AIR MIX KIT with prechamber</b>				<b>SKT0031</b>	<b>SKT0032</b>	<b>SKT0033</b>
<b>WATER PLAYS KIT (Waterbell + Daisy)</b>				<b>SKT0030</b>	<b>SKT0030</b>	<b>SKT0030</b>