

FPS
serie SS

**BOMBAS DE
ACERO
INOXIDABLE**
6", 8", 10"



50 Hz





El valor oculto
en su
proyecto



Hidden value
of your
project

FPS

Instrucciones	4
---------------------	---

Dimensiones - Carga Dinámica Total - Curvas de Rendimiento

6"	5
SS 609	6
SS 612	10
SS 615	14
SS 624	18
SS 630	22
SS 636	24
SS 642	26
SS 660	28
SS 675	30
SS 690	32
8"	47
SS 872	48
SS 896	50
10"	55
SS 10108	56
SS 10120	58
SS 10160	60
SS 10215	62

Componentes e montaje

6"	
SS 609	34
SS 612	36
SS 615	38
SS 624 - SS 630	40
SS 636 - SS 642 - SS 660.....	42
SS 675 - SS 690	44
8"	
SS 872 - SS 896	52
10"	
SS 10108 - SS 10120 - SS 10160	64
SS 10215	66

INSTRUCCIONES



1 - NOMENCLATURA DEL PRODUCTO

SS 630/18



2 - INTERPRETACIÓN DE LAS CURVAS

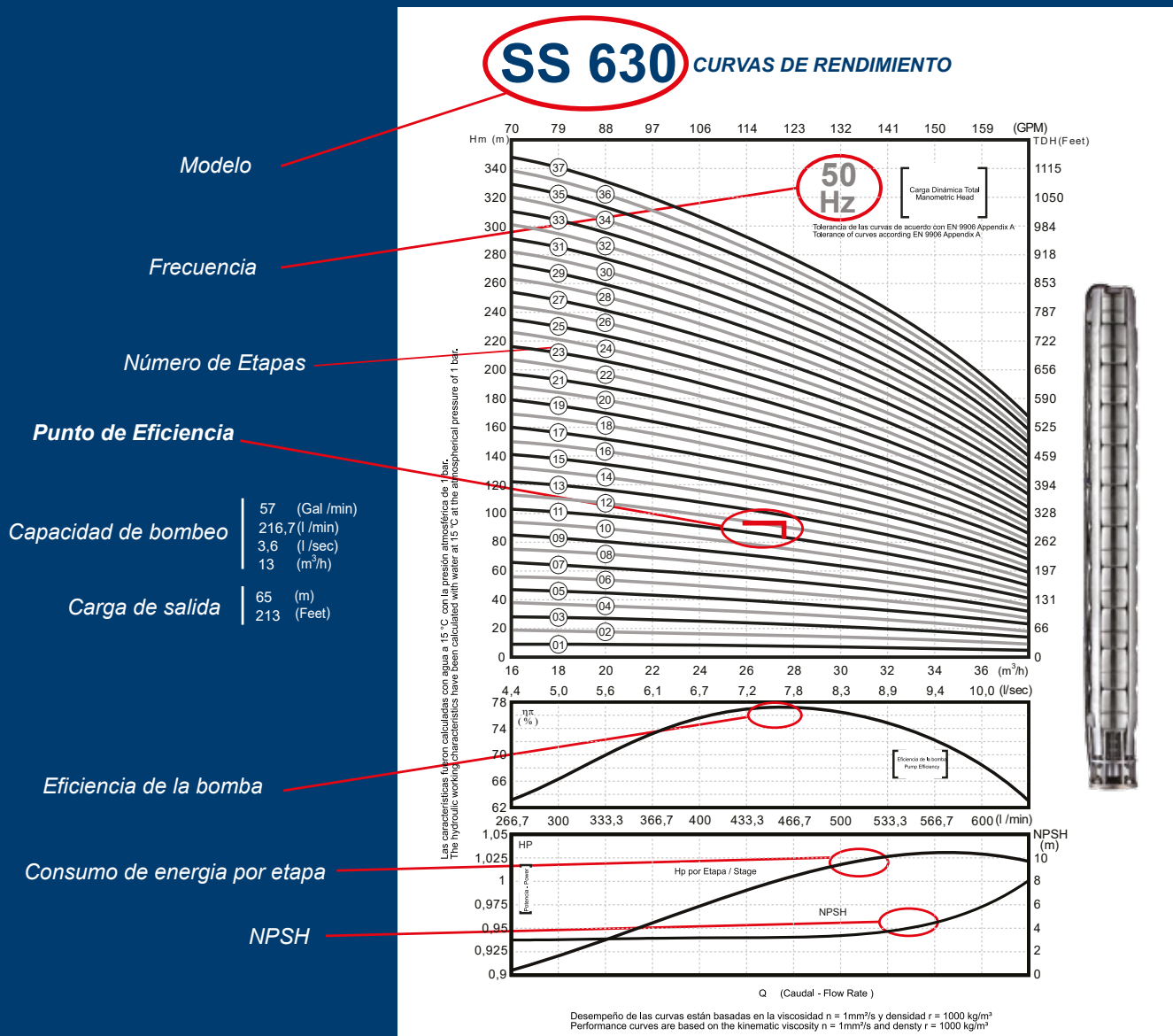

6



FPS
serie SS

SS 609



BOMBAS DE ACERO INOXIDABLE
50 Hz

Especificaciones

- Rango de operación en 50hz: Q = 6 m³/h - 14 m³/h
- Descarga: 2 1/2" con hilo en descarga 11 TPI
- Tipo del impulsor: flujo mixto
- Sentido de rotación: anti horaria
- Conexión: según estándar NEMA
- Diametro del eje: 20mm
- Diametro máximo de la bomba: 133mm (incluyendo guarda cable)
- Estándares de seguridad y fabricación:
 - TS 11146:2014
 - EN 809:1998+A1+2009+AC:2010

2006/42/EC
EN ISO 12100:2010

- Líquido a bombear: agua limpia
- Paso máximo de sólidos: 2 mm
- Concentración máxima de sólidos: 50 PPM
- Nivel mínimo de líquido (NPSH): 800mm desde el fondo de la ranura de succión

Fecha 03/2016 | Rev 01

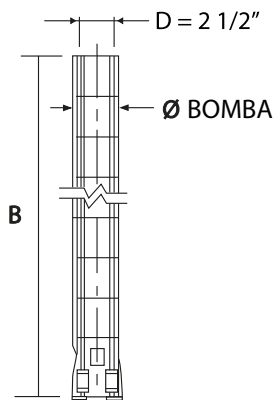

MODELO	MOTOR			ETAPAS	DIMENSIONES (mm)				PESO (kg)	
	4" HP	6" HP	kW		6"-4"	6"-6"	Ø BOMBA	Ø D	BOMBA	
					B	B			6"-4"	6"-6"
SS 609/01	0,75	-	0,55	1	330	-	133	2 1/2"	6	-
SS 609/02	1	-	0,75	2	391	-	133	2 1/2"	8	-
SS 609/03	1,5	-	1,1	3	451	-	133	2 1/2"	9	-
SS 609/04	2	-	1,5	4	512	-	133	2 1/2"	10	-
SS 609/05	2	-	1,5	5	572	-	133	2 1/2"	11	-
SS 609/06	3	-	2,2	6	633	-	133	2 1/2"	12	-
SS 609/07	3	-	2,2	7	693	-	133	2 1/2"	14	-
SS 609/08	4	-	3	8	754	-	133	2 1/2"	15	-
SS 609/09	4	-	3	9	814	-	133	2 1/2"	16	-
SS 609/10	5,5	5,5	4	10	875	875	133	2 1/2"	19	19
SS 609/11	5,5	5,5	4	11	935	935	133	2 1/2"	20	20
SS 609/12	5,5	5,5	4	12	996	996	133	2 1/2"	21	21
SS 609/13	5,5	5,5	4	13	1056	1056	133	2 1/2"	22	22
SS 609/14	7,5	7,5	5,5	14	1117	1117	133	2 1/2"	23	23
SS 609/15	7,5	7,5	5,5	15	1177	1177	133	2 1/2"	25	25
SS 609/16	7,5	7,5	5,5	16	1238	1238	133	2 1/2"	26	26
SS 609/17	7,5	7,5	5,5	17	1298	1298	133	2 1/2"	27	27
SS 609/18	7,5	7,5	5,5	18	1359	1359	133	2 1/2"	28	28
SS 609/19	10	10	7,5	19	1419	1419	133	2 1/2"	29	29
SS 609/20	10	10,0	7,5	20	1480	1480	133	2 1/2"	30	30
SS 609/21	10	10	7,5	21	1540	1540	133	2 1/2"	32	32

MODELO	MOTOR			m ³ /h	CARGA DINÁMICA TOTAL (m)													
	4" HP	6" HP	kW		0	6	7	8	9	10	11	12	13	14				
					l / seg	0,00	1,67	1,94	2,22	2,50	2,78	3,06	3,33	3,61	3,89			
				gpm	0	26	31	35	40	44	48	53	57	62				
SS 609/01	0,75	-	0,55		9	9	9	8	8	8	7	7	6	5				
SS 609/02	1	-	0,75		19	18	17	17	16	15	14	13	12	11				
SS 609/03	1,5	-	1,1		28	27	26	25	24	23	21	20	18	16				
SS 609/04	2	-	1,5		38	35	35	34	32	31	28	26	24	22				
SS 609/05	2	-	1,5		47	44	43	42	41	38	35	33	30	27				
SS 609/06	3	-	2,2		57	53	52	51	49	46	43	40	36	33				
SS 609/07	3	-	2,2		66	62	61	59	57	53	50	46	42	38				
SS 609/08	4	-	3		75	71	69	68	65	61	57	53	48	43				
SS 609/09	4	-	3		85	80	78	76	73	69	64	59	54	49				
SS 609/10	5,5	5,5	4		94	89	87	85	81	76	71	66	60	54				
SS 609/11	5,5	5,5	4		104	97	95	93	89	84	78	73	66	60				
SS 609/12	5,5	5,5	4		113	106	104	102	97	92	85	79	72	65				
SS 609/13	5,5	5,5	4		122	115	113	110	105	99	92	86	78	71				
SS 609/14	7,5	7,5	5,5		132	124	121	118	114	107	99	92	84	76				
SS 609/15	7,5	7,5	5,5		141	133	130	127	122	115	106	99	90	81				
SS 609/16	7,5	7,5	5,5		151	142	139	135	130	122	113	106	96	87				
SS 609/17	7,5	7,5	5,5		160	151	147	144	138	130	120	112	102	92				
SS 609/18	7,5	7,5	5,5		170	160	156	152	146	137	128	119	108	98				
SS 609/19	10	10	7,5		179	168	165	161	154	145	135	125	115	103				
SS 609/20	10	10	7,5		188	177	173	169	162	153	142	132	121	109				
SS 609/21	10	10	7,5		198	186	182	178	170	160	149	139	127	114				

SS 609



**BOMBAS DE ACERO
INOXIDABLE**
50 Hz

Curvas de Rendimiento - 01 a 21 etapas

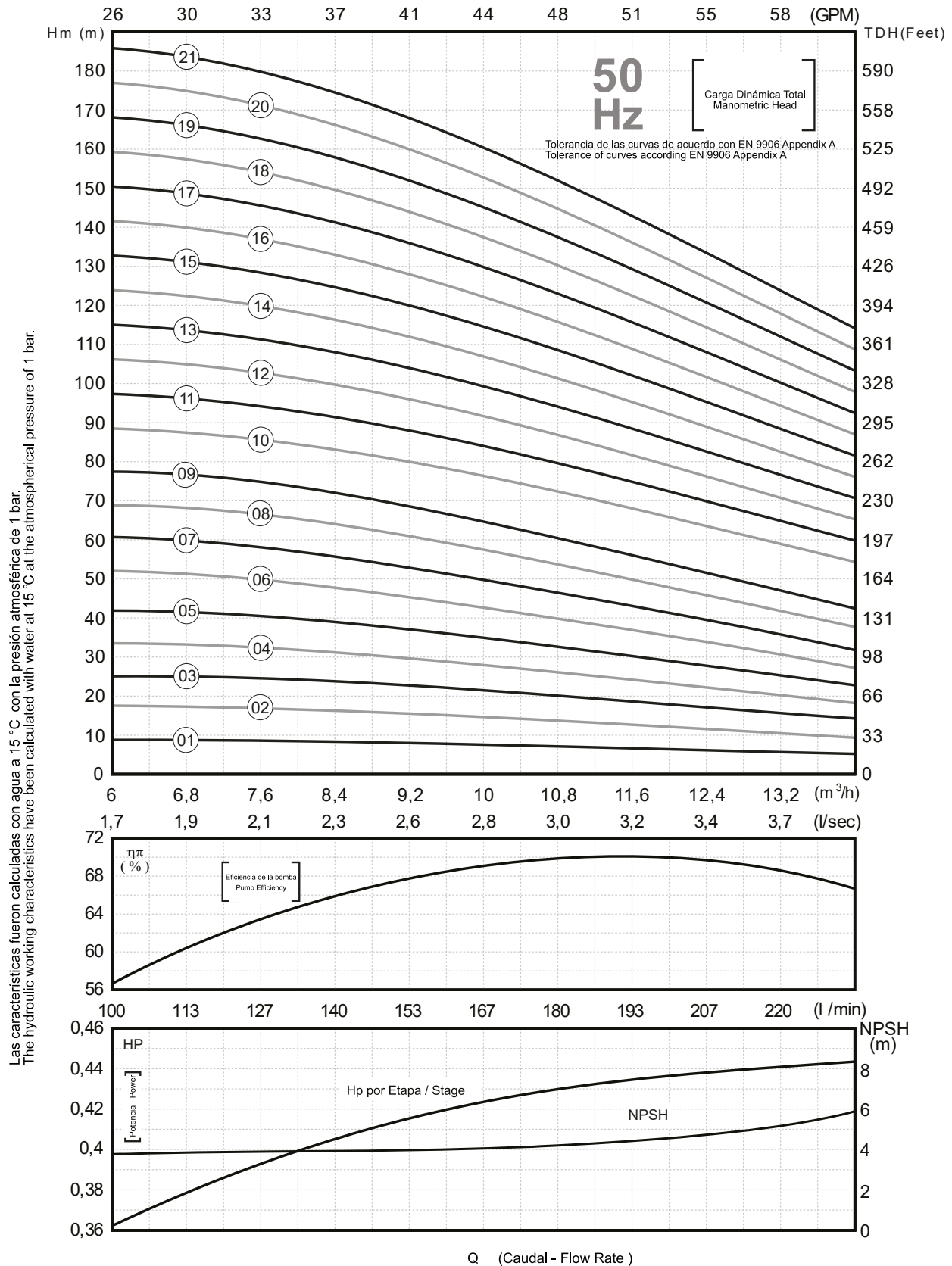

Desempeño de las curvas están basadas en la viscosidad $\nu = 1 \text{ mm}^2/\text{s}$ y densidad $\rho = 1000 \text{ kg/m}^3$
Performance curves are based on the kinematic viscosity $\nu = 1 \text{ mm}^2/\text{s}$ and density $\rho = 1000 \text{ kg/m}^3$

SS 609



BOMBAS DE ACERO INOXIDABLE
50 Hz

Especificaciones

- Rango de operación en 50hz: Q = 6 m³/h - 14 m³/h
 - Descarga: 2 1/2" con hilo en descarga 11 TPI
 - Tipo del impulsor: flujo mixto
 - Sentido de rotación: anti horaria
 - Conexión: según estándar NEMA
 - Diametro del eje: 20mm
 - Diametro máximo de la bomba: 133mm (incluyendo guarda cable)
- Estándares de seguridad y fabricación:
 - TS 11146:2014
 - EN 809:1998+A1+2009+AC:2010

2006/42/EC
EN ISO 12100:2010

- Líquido a bombear: agua limpia
- Paso máximo de sólidos: 2 mm
- Concentración máxima de sólidos: 50 PPM
- Nivel mínimo de líquido (NPSH): 800mm desde el fondo de la ranura de succión

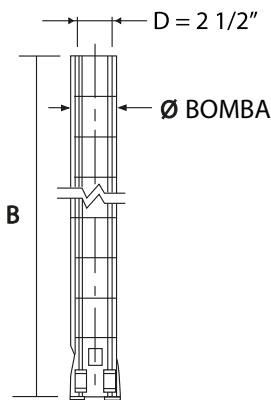

MODELO	MOTOR			ETAPAS	DIMENSIONES (mm)				PESO (kg)	
	4" HP	6" HP	kW		6"-4"	6"-6"	ø BOMBA	ø D	BOMBA	
					B	B			6"-4"	6"-6"
SS 609/22	10	10	7,5	22	1617	1617	133	2 1/2"	34	34
SS 609/23	10	10	7,5	23	1677	1677	133	2 1/2"	35	35
SS 609/24	10	10	7,5	24	1738	1738	133	2 1/2"	36	36
SS 609/25	-	12,5	9,2	25	-	1798	133	2 1/2"	-	37
SS 609/26	-	12,5	9,2	26	-	1859	133	2 1/2"	-	39
SS 609/27	-	12,5	9,2	27	-	1919	133	2 1/2"	-	40
SS 609/28	-	12,5	9,2	28	-	1980	133	2 1/2"	-	41
SS 609/29	-	15	11	29	-	2040	133	2 1/2"	-	42
SS 609/30	-	15	11	30	-	2101	133	2 1/2"	-	43
SS 609/31	-	15	11	31	-	2161	133	2 1/2"	-	45
SS 609/32	-	15	11	32	-	2222	133	2 1/2"	-	46
SS 609/33	-	15	11	33	-	2282	133	2 1/2"	-	47
SS 609/34	-	15	11	34	-	2343	133	2 1/2"	-	48
SS 609/35	-	15	11	35	-	2403	133	2 1/2"	-	49
SS 609/36	-	20	15	36	-	2464	133	2 1/2"	-	51
SS 609/37	-	20	15	37	-	2524	133	2 1/2"	-	52
SS 609/38	-	20	15	38	-	2585	133	2 1/2"	-	53
SS 609/39	-	20	15	39	-	2645	133	2 1/2"	-	54
SS 609/40	-	20	15	40	-	2706	133	2 1/2"	-	55
SS 609/41	-	20	15	41	-	2766	133	2 1/2"	-	57
SS 609/42	-	20	15	42	-	2827	133	2 1/2"	-	58

MODELO	MOTOR			m ³ /h	CARGA DINÁMICA TOTAL (m)													
	4" HP	6" HP	kW		l / seg	0	6	7	8	9	10	11	12	13	14			
						gpm	0,00	1,67	1,94	2,22	2,50	2,78	3,06	3,33	3,61	3,89		
SS 609/22	10	10	7,5	207	195	191	186	178	168	156	145	133	119					
SS 609/23	10	10	7,5	217	204	199	195	186	176	163	152	139	125					
SS 609/24	10	10	7,5	226	213	208	203	195	183	170	158	145	130					
SS 609/25	-	12,5	9,2	235	222	217	212	203	191	177	165	151	136					
SS 609/26	-	12,5	9,2	245	230	225	220	211	199	184	172	157	141					
SS 609/27	-	12,5	9,2	254	239	234	228	219	206	191	178	163	147					
SS 609/28	-	12,5	9,2	264	248	243	237	227	214	198	185	169	152					
SS 609/29	-	15	11	273	257	251	245	235	221	206	191	175	157					
SS 609/30	-	15	11	283	266	260	254	243	229	213	198	181	163					
SS 609/31	-	15	11	292	275	269	262	251	237	220	205	187	168					
SS 609/32	-	15	11	301	284	277	271	259	244	227	211	193	174					
SS 609/33	-	15	11	311	292	286	279	268	252	234	218	199	179					
SS 609/34	-	15	11	320	301	295	288	276	260	241	224	205	185					
SS 609/35	-	15	11	330	310	303	296	284	267	248	231	211	190					
SS 609/36	-	20	15	339	319	312	305	292	275	255	237	217	195					
SS 609/37	-	20	15	349	328	321	313	300	283	262	244	223	201					
SS 609/38	-	20	15	358	337	329	322	308	290	269	251	229	206					
SS 609/39	-	20	15	367	346	338	330	316	298	276	257	235	212					
SS 609/40	-	20	15	377	354	347	338	324	306	284	264	241	217					
SS 609/41	-	20	15	386	363	355	347	332	313	291	270	247	223					
SS 609/42	-	20	15	396	372	364	355	341	321	298	277	253	228					

SS 609



**BOMBAS DE ACERO
INOXIDABLE**
50 Hz

Curvas de Rendimiento - 22 a 42 etapas

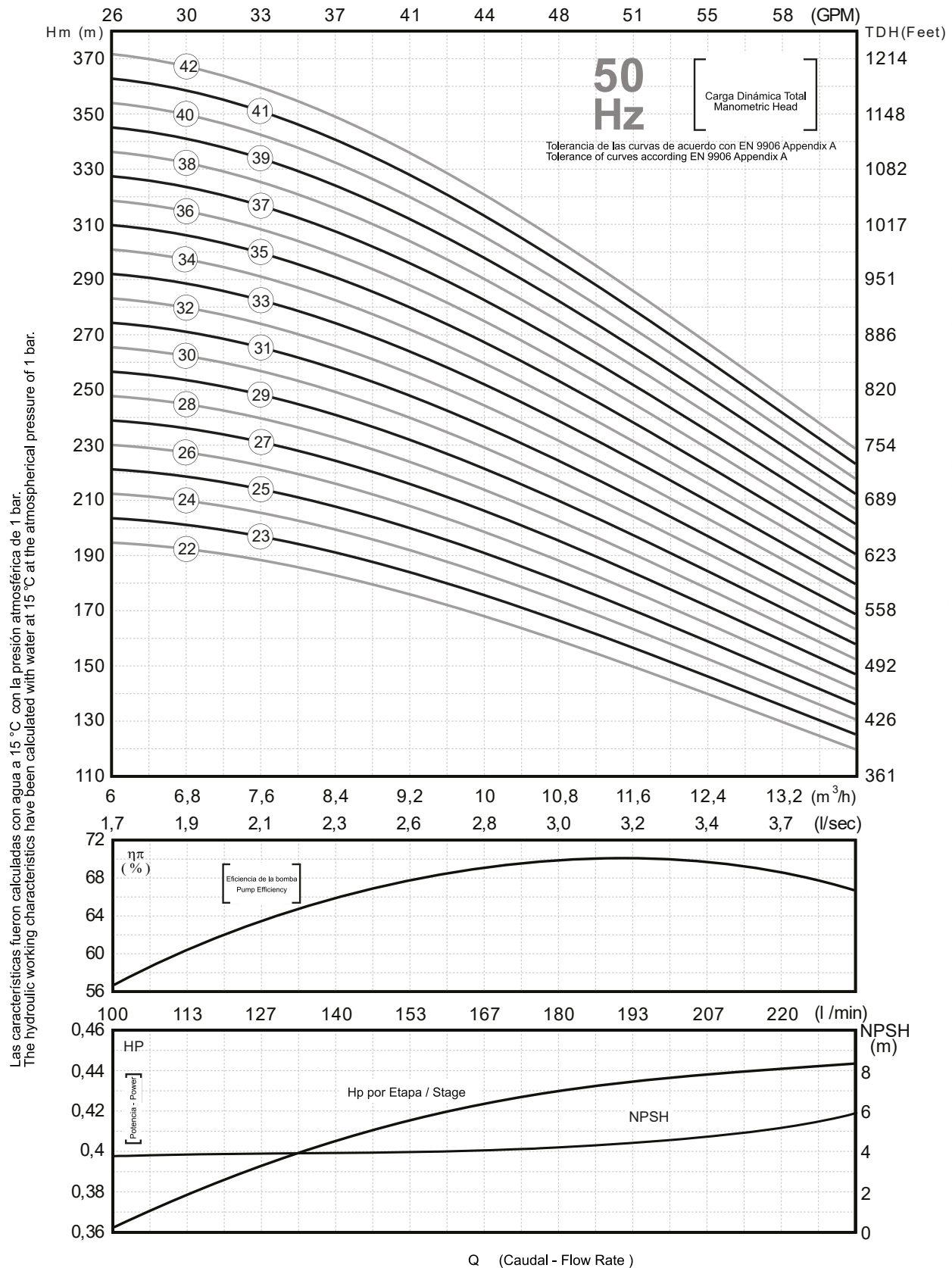

Desempeño de las curvas están basadas en la viscosidad $\nu = 1\text{mm}^2/\text{s}$ y densidad $\rho = 1000\text{ kg/m}^3$
Performance curves are based on the kinematic viscosity $\nu = 1\text{mm}^2/\text{s}$ and density $\rho = 1000\text{ kg/m}^3$



SS 612



**BOMBAS DE ACERO
INOXIDABLE**
50 Hz

Especificaciones

- Rango de operación en 50Hz: Q = 7 m³/h - 18 m³/h
- Descarga: 2 1/2" con hilo en descarga 11 TPI
- Tipo del impulsor: flujo mixto
- Sentido de rotación: anti horaria
- Conexión: según estándar NEMA
- Diámetro del eje: 19mm Hexagonal
- Diámetro máximo de la bomba: 133mm (incluyendo guarda cable)
- Estándares de seguridad y fabricación:
 - TS 11146:2014
 - EN 809:1998+A1+2009+AC:2010

- Líquido a bombear: agua limpia
- Paso máximo de sólidos: 2 mm
- Concentración máxima de sólidos: 50 PPM
- Nivel mínimo de líquido (NPSH): 800mm desde el fondo de la ranura de succión

2006/42/EC
EN ISO 12100:2010

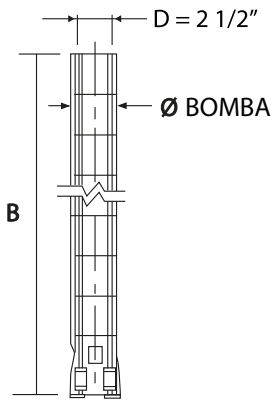

MODELO	MOTOR			ETAPAS	DIMENSIONES (mm)				PESO (kg)	
	4" HP	6" HP	kW		6"-4"	6"-6"	ø BOMBA	ø D	BOMBA	
					B	B			6"-4"	6"-6"
SS 612/05	4	-	3	5	498	-	133	2 1/2"	12	-
SS 612/06	4	-	3	6	528	-	133	2 1/2"	12	-
SS 612/07	5,5	5,5	4	7	558	558	133	2 1/2"	13	13
SS 612/08	5,5	5,5	4	8	589	589	133	2 1/2"	14	14
SS 612/09	5,5	5,5	4	9	619	619	133	2 1/2"	14	15
SS 612/10	7,5	7,5	5,5	10	649	649	133	2 1/2"	15	16
SS 612/11	7,5	7,5	5,5	11	679	679	133	2 1/2"	16	17
SS 612/12	7,5	7,5	5,5	12	709	709	133	2 1/2"	17	17
SS 612/13	7,5	7,5	5,5	13	740	740	133	2 1/2"	17	18
SS 612/14	10	10	7,5	14	770	770	133	2 1/2"	18	19
SS 612/15	10	10	7,5	15	800	800	133	2 1/2"	19	20
SS 612/16	10	10	7,5	16	830	830	133	2 1/2"	20	21
SS 612/17	10	10	7,5	17	860	860	133	2 1/2"	21	22
SS 612/18	-	12,5	9,2	18	-	891	133	2 1/2"	-	23
SS 612/19	-	12,5	9,2	19	-	921	133	2 1/2"	-	23
SS 612/20	-	12,5	9,2	20	-	951	133	2 1/2"	-	24
SS 612/21	-	12,5	9,2	21	-	981	133	2 1/2"	-	25
SS 612/22	-	12,5	9,2	22	-	1011	133	2 1/2"	-	26
SS 612/23	-	15	11	23	-	1042	133	2 1/2"	-	27
SS 612/24	-	15	11	24	-	1072	133	2 1/2"	-	28

MODELO	MOTOR			m ³ /h	CARGA DINÁMICA TOTAL (m)														
	4" HP	6" HP	kW		l / seg	gpm													
						0,00	1,94	2,22	2,50	2,78	3,06	3,33	3,61	3,89	4,17	4,44	4,72	5,00	
SS 612/05	4	-	3	55	49	48	47	45	42	39	36	32	28	24	19	15			
SS 612/06	4	-	3	65	59	58	56	53	50	46	43	38	33	28	23	18			
SS 612/07	5,5	5,5	4	76	69	67	65	62	59	54	50	45	39	33	27	21			
SS 612/08	5,5	5,5	4	87	78	77	74	71	67	62	57	51	44	38	30	24			
SS 612/09	5,5	5,5	4	98	88	86	84	80	76	69	64	58	50	42	34	27			
SS 612/10	7,5	7,5	5,5	109	98	96	93	89	84	77	71	64	55	47	38	30			
SS 612/11	7,5	7,5	5,5	120	108	106	102	98	92	85	78	70	61	52	42	33			
SS 612/12	7,5	7,5	5,5	131	118	115	112	107	101	92	85	77	66	56	46	36			
SS 612/13	7,5	7,5	5,5	142	127	125	121	116	109	100	92	83	72	61	49	39			
SS 612/14	10	10	7,5	153	137	134	130	125	118	108	99	90	77	66	53	42			
SS 612/15	10	10	7,5	164	147	144	140	134	126	116	107	96	83	71	57	45			
SS 612/16	10	10	7,5	174	157	154	149	142	134	123	114	102	88	75	61	48			
SS 612/17	10	10	7,5	185	167	163	158	151	143	131	121	109	94	80	65	51			
SS 612/18	-	12,5	9,2	196	176	173	167	160	151	139	128	115	99	85	68	54			
SS 612/19	-	12,5	9,2	207	186	182	177	169	160	146	135	122	105	89	72	57			
SS 612/20	-	12,5	9,2	218	196	192	186	178	168	154	142	128	110	94	76	60			
SS 612/21	-	12,5	9,2	229	206	202	195	187	176	162	149	134	116	99	80	63			
SS 612/22	-	12,5	9,2	240	216	211	205	196	185	169	156	141	121	103	84	66			
SS 612/23	-	15	11,0	251	225	221	214	205	193	177	163	147	127	108	87	69			
SS 612/24	-	15	11,0	262	235	230	223	214	202	185	170	154	132	113	91	72			

SS 612



**BOMBAS DE ACERO
INOXIDABLE**
50 Hz

Curvas de Rendimiento - 05 a 24 etapas

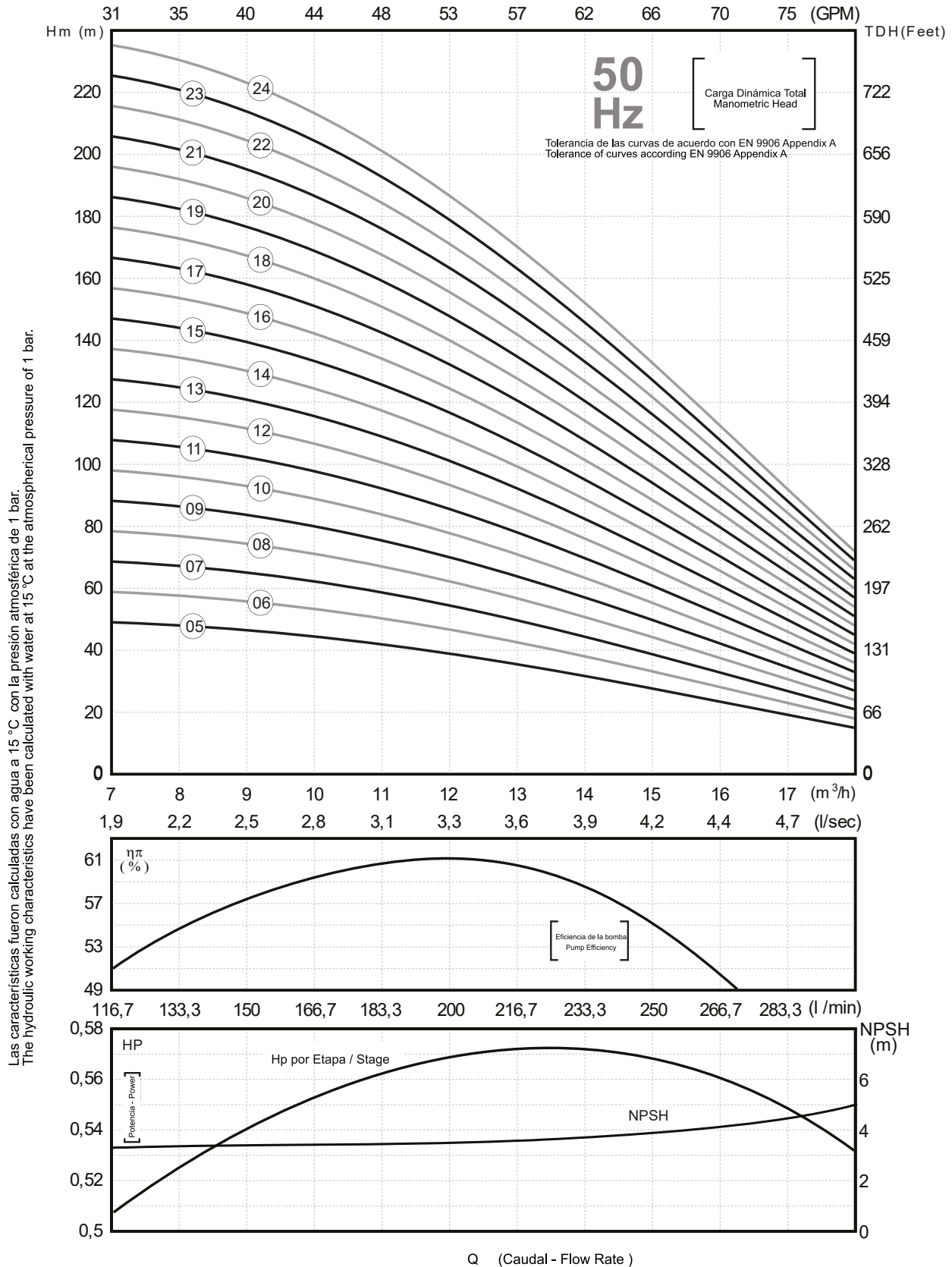

Desempeño de las curvas están basadas en la viscosidad $\nu = 1\text{mm}^2/\text{s}$ y densidad $\rho = 1000\text{ kg/m}^3$
Performance curves are based on the kinematic viscosity $\nu = 1\text{mm}^2/\text{s}$ and density $\rho = 1000\text{ kg/m}^3$

SS 612



**BOMBAS DE ACERO
INOXIDABLE**
50 Hz

Especificaciones

- Rango de operación en 50hz: Q = 7 m³/h - 18 m³/h
- Descarga: 2 1/2" con hilo en descarga 11 TPI
- Tipo del impulsor: flujo mixto
- Sentido de rotación: anti horaria
- Conexión: según estándar NEMA
- Diametro del eje: 19mm Hexagonal
- Diametro máximo de la bomba: 133mm (incluyendo guarda cable)
- Estándares de seguridad y fabricación:
 - TS 11146:2014
 - EN 809:1998+A1+2009+AC:2010

- Líquido a bombear: agua limpia
- Paso máximo de sólidos: 2 mm
- Concentración máxima de sólidos: 50 PPM
- Nivel mínimo de líquido (NPSH): 800mm desde el fondo de la ranura de succión

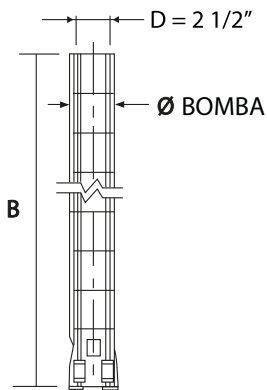

MODELO	MOTOR			ETAPAS	DIMENSIONES (mm)				PESO (kg)	
	4" HP	6" HP	kW		6"-4"	6"-6"	Ø BOMBA	Ø D	BOMBA	
					B	B			6"-4"	6"-6"
SS 612/25	-	15	11	25	-	1102	133	2 1/2"	-	29
SS 612/26	-	15	11	26	-	1132	133	2 1/2"	-	29
SS 612/27	-	20	15	27	-	1162	133	2 1/2"	-	30
SS 612/28	-	20	15	28	-	1193	133	2 1/2"	-	31
SS 612/29	-	20	15	29	-	1223	133	2 1/2"	-	32
SS 612/30	-	20	15	30	-	1253	133	2 1/2"	-	33
SS 612/31	-	20	15	31	-	1283	133	2 1/2"	-	34
SS 612/32	-	20	15	32	-	1313	133	2 1/2"	-	35
SS 612/33	-	20	15	33	-	1344	133	2 1/2"	-	35
SS 612/34	-	20	15	34	-	1374	133	2 1/2"	-	36
SS 612/35	-	20	15	35	-	1404	133	2 1/2"	-	37
SS 612/36	-	20	15	36	-	1434	133	2 1/2"	-	38
SS 612/37	-	25	18,5	37	-	1464	133	2 1/2"	-	39
SS 612/38	-	25	18,5	38	-	1495	133	2 1/2"	-	40
SS 612/39	-	25	18,5	39	-	1525	133	2 1/2"	-	41
SS 612/40	-	25	18,5	40	-	1555	133	2 1/2"	-	41

MODELO	MOTOR			m ³ /h	0	7	8	9	10	11	12	13	14	15	16	17	18	
	4" HP	6" HP	kW		l / seg	0,00	1,94	2,22	2,50	2,78	3,06	3,33	3,61	3,89	4,17	4,44	4,72	5,00
					gpm	0	31	35	40	44	48	53	57	62	66	70	75	79
SS 612/25	-	15	11	CARGA DINÁMICA TOTAL (m)	273	245	240	233	223	210	193	178	160	138	118	95	75	
SS 612/26	-	15	11		283	255	250	242	231	218	200	185	166	143	122	99	78	
SS 612/27	-	20	15		294	265	259	251	240	227	208	192	173	149	127	103	81	
SS 612/28	-	20	15		305	274	269	260	249	235	216	199	179	154	132	106	84	
SS 612/29	-	20	15		316	284	278	270	258	244	223	206	186	160	136	110	87	
SS 612/30	-	20	15		327	294	288	279	267	252	231	213	192	165	141	114	90	
SS 612/31	-	20	15		338	304	298	288	276	260	239	220	198	171	146	118	93	
SS 612/32	-	20	15		349	314	307	298	285	269	246	227	205	176	150	122	96	
SS 612/33	-	20	15		360	323	317	307	294	277	254	234	211	182	155	125	99	
SS 612/34	-	20	15		371	333	326	316	303	286	262	241	218	187	160	129	102	
SS 612/35	-	20	15		382	343	336	326	312	294	270	249	224	193	165	133	105	
SS 612/36	-	20	15		392	353	346	335	320	302	277	256	230	198	169	137	108	
SS 612/37	-	25	18,5		403	363	355	344	329	311	285	263	237	204	174	141	111	
SS 612/38	-	25	18,5		414	372	365	353	338	319	293	270	243	209	179	144	114	
SS 612/39	-	25	18,5		425	382	374	363	347	328	300	277	250	215	183	148	117	
SS 612/40	-	25	18,5		436	392	384	372	356	336	308	284	256	220	188	152	120	

Fecha 03/2016 | Rev 01

Franklin Electric reserva el derecho a modificar productos sin previo aviso.

SS 612



**BOMBAS DE ACERO
INOXIDABLE**
50 Hz

Curvas de Rendimiento - 25 a 40 etapas

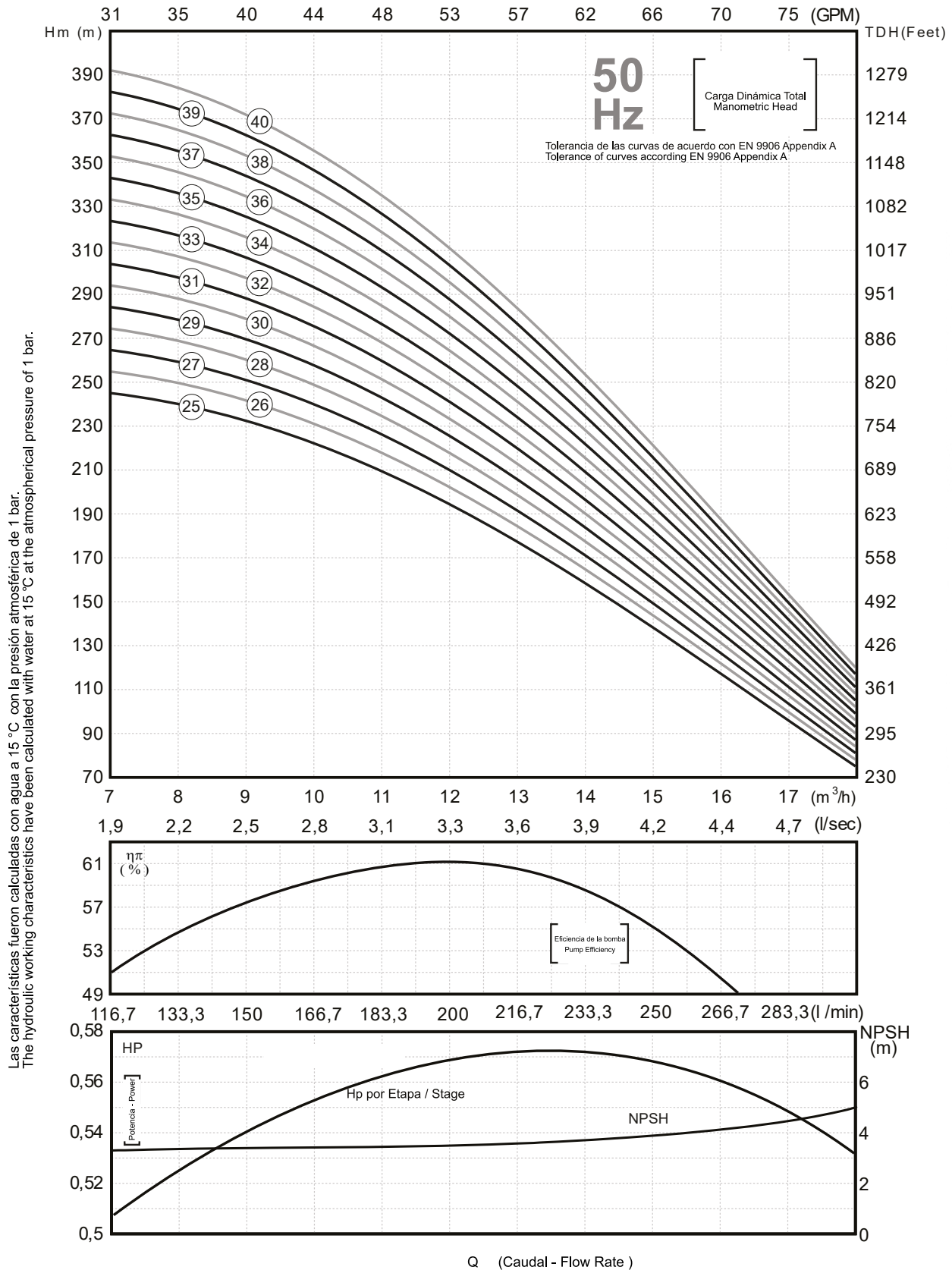

Desempeño de las curvas están basadas en la viscosidad $\nu = 1\text{mm}^2/\text{s}$ y densidad $\rho = 1000\text{ kg/m}^3$
Performance curves are based on the kinematic viscosity $\nu = 1\text{mm}^2/\text{s}$ and density $\rho = 1000\text{ kg/m}^3$

SS 615



**BOMBAS DE ACERO
INOXIDABLE**
50 Hz

Especificaciones

- Rango de operación en 50hz: Q = 10 m³/h - 19 m³/h
- Descarga: 2 1/2" con hilo en descarga 11 TPI
- Tipo del impulsor: flujo mixto
- Sentido de rotación: anti horaria
- Conexión: según estándar NEMA
- Diámetro del eje: 20mm
- Diámetro máximo de la bomba: 133mm (incluyendo guarda cable)
- Estándares de seguridad y fabricación:
 - TS 11146:2014
 - EN 809:1998+A1+2009+AC:2010

- Líquido a bombear: agua limpia
- Paso máximo de sólidos: 2 mm
- Concentración máxima de sólidos: 50 PPM
- Nivel mínimo de líquido (NPSH): 800mm desde el fondo de la ranura de succión

2006/42/EC
EN ISO 12100:2010

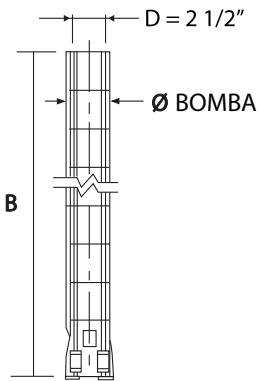

MODELO	MOTOR			ETAPAS	DIMENSIONES (mm)				PESO (kg)	
	4" HP	6" HP	kW		6"-4"	6"-6"	Ø BOMBA	Ø D	BOMBA	
					B	B			6"-4"	6"-6"
SS 615/01	0,75	-	0,55	1	330	-	133	2 1/2"	6	-
SS 615/02	1,5	-	1,1	2	391	-	133	2 1/2"	8	-
SS 615/03	2	-	1,5	3	451	-	133	2 1/2"	9	-
SS 615/04	3	-	2,2	4	512	-	133	2 1/2"	10	-
SS 615/05	3	-	2,2	5	572	-	133	2 1/2"	11	-
SS 615/06	4	-	3	6	633	-	133	2 1/2"	12	-
SS 615/07	5,5	5,5	4	7	693	693	133	2 1/2"	14	15
SS 615/08	5,5	5,5	4	8	754	754	133	2 1/2"	15	16
SS 615/09	5,5	5,5	4	9	814	814	133	2 1/2"	16	17
SS 615/10	7,5	7,5	5,5	10	875	875	133	2 1/2"	17	19
SS 615/11	7,5	7,5	5,5	11	935	935	133	2 1/2"	19	20
SS 615/12	7,5	7,5	5,5	12	996	996	133	2 1/2"	20	21
SS 615/13	10	10	7,5	13	1056	1056	133	2 1/2"	21	22
SS 615/14	10	10	7,5	14	1116,5	1117	133	2 1/2"	22	23
SS 615/15	10	10	7,5	15	1177	1177	133	2 1/2"	24	25
SS 615/16	10	10	7,5	16	1237,5	1238	133	2 1/2"	25	26
SS 615/17	-	12,5	9,2	17	-	1298	133	2 1/2"	-	27
SS 615/18	-	12,5	9,2	18	-	1359	133	2 1/2"	-	28
SS 615/19	-	12,5	9,2	19	-	1419	133	2 1/2"	-	29
SS 615/20	-	12,5	9,2	20	-	1480	133	2 1/2"	-	30

MODELO	MOTOR			m³/h	0	10	11	12	13	14	15	16	17	18	19	
	4" HP	6" HP	kW		l / seg	0,00	2,78	3,06	3,33	3,61	3,89	4,17	4,44	4,72	5,00	5,28
					gpm	0	44	48	53	57	62	66	70	75	79	84
SS 615/01	0,75	-	0,55	CARGA DINÁMICA TOTAL (m)	12	9	9	9	8	8	8	7	7	6	6	
SS 615/02	1,5	-	1,1		24	19	18	18	17	17	16	15	14	13	12	
SS 615/03	2	-	1,5		36	29	27	27	26	25	24	23	21	20	18	
SS 615/04	3	-	2,2		48	39	37	36	34	34	32	30	29	27	25	
SS 615/05	3	-	2,2		60	49	46	45	43	42	40	38	36	34	31	
SS 615/06	4	-	3		72	58	55	54	52	51	48	46	43	40	37	
SS 615/07	5,5	5,5	4		84	68	65	63	60	59	56	53	51	47	44	
SS 615/08	5,5	5,5	4		96	78	74	72	69	68	64	61	58	54	50	
SS 615/09	5,5	5,5	4		108	88	83	81	78	76	72	69	65	61	56	
SS 615/10	7,5	7,5	5,5		120	98	93	90	87	85	80	77	73	68	63	
SS 615/11	7,5	7,5	5,5		132	107	102	99	95	93	88	84	80	74	69	
SS 615/12	7,5	7,5	5,5		144	117	111	108	104	102	96	92	87	81	75	
SS 615/13	10	10	7,5		156	127	120	117	113	110	104	100	94	88	81	
SS 615/14	10	10	7,5		168	137	130	125	121	119	112	107	102	95	88	
SS 615/15	10	10	7,5		180	147	139	134	130	127	120	115	109	102	94	
SS 615/16	10	10	7,5		192	156	148	143	139	136	128	123	116	108	100	
SS 615/17	-	12,5	9,2		204	166	158	152	147	144	136	130	124	115	107	
SS 615/18	-	12,5	9,2		216	176	167	161	156	153	144	138	131	122	113	
SS 615/19	-	12,5	9,2		228	186	176	170	165	161	152	146	138	129	119	
SS 615/20	-	12,5	9,2		240	196	186	179	174	170	160	154	146	136	126	

Fecha 03/2016 | Rev 01

Franklin Electric reserva el derecho a modificar productos sin previo aviso.

SS 615



BOMBAS DE ACERO INOXIDABLE
50 Hz

Curvas de Rendimiento - 01 a 20 etapas

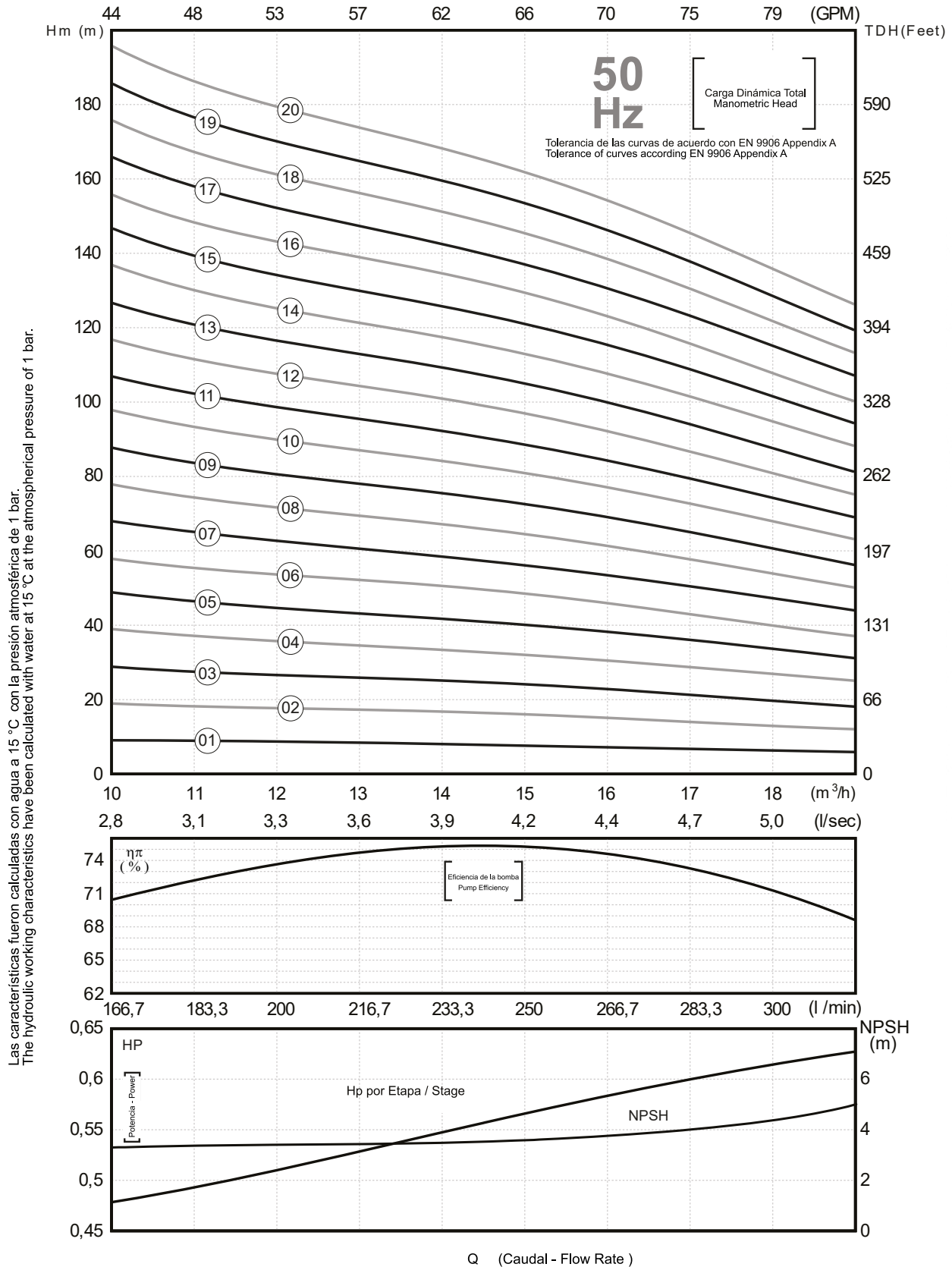

Desempeño de las curvas están basadas en la viscosidad $\nu = 1\text{mm}^2/\text{s}$ y densidad $\rho = 1000\text{kg}/\text{m}^3$
Performance curves are based on the kinematic viscosity $\nu = 1\text{mm}^2/\text{s}$ and density $\rho = 1000\text{kg}/\text{m}^3$

SS 615



**BOMBAS DE ACERO
INOXIDABLE**
50 Hz

Especificaciones

- Rango de operación en 50hz: Q = 10 m³/h - 19 m³/h
- Descarga: 2 1/2" con hilo en descarga 11 TPI
- Tipo del impulsor: flujo mixto
- Sentido de rotación: anti horaria
- Conexión: según estándar NEMA
- Diametro del eje: 20mm
- Diametro máximo de la bomba: 133mm (incluyendo guarda cable)
- Estándares de seguridad y fabricación:
 - TS 11146:2014
 - EN 809:1998+A1+2009+AC:2010

- Líquido a bombear: agua limpia
- Paso máximo de sólidos: 2 mm
- Concentración máxima de sólidos: 50 PPM
- Nivel mínimo de líquido (NPSH): 800mm desde el fondo de la ranura de succión

2006/42/EC
EN ISO 12100:2010

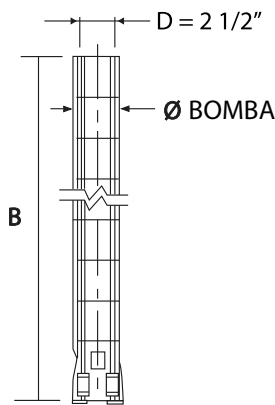

MODELO	MOTOR			ETAPAS	DIMENSIONES (mm)				PESO (kg)	
	4" HP	6" HP	kW		6"-4"	6"-6"	Ø BOMBA	Ø D	BOMBA	
					B	B			6"-4"	6"-6"
SS 615/21	-	15	11	21	-	1540	133	2 1/2"	-	32
SS 615/22	-	15	11	22	-	1616,5	133	2 1/2"	-	34
SS 615/23	-	15	11	23	-	1677	133	2 1/2"	-	35
SS 615/24	-	15	11	24	-	1738	133	2 1/2"	-	36
SS 615/25	-	15	11	25	-	1798	133	2 1/2"	-	37
SS 615/26	-	20	15	26	-	1859	133	2 1/2"	-	39
SS 615/27	-	20	15	27	-	1919	133	2 1/2"	-	40
SS 615/28	-	20	15	28	-	1980	133	2 1/2"	-	41
SS 615/29	-	20	15	29	-	2040	133	2 1/2"	-	42
SS 615/30	-	20	15	30	-	2101	133	2 1/2"	-	43
SS 615/31	-	20	15	31	-	2161	133	2 1/2"	-	45
SS 615/32	-	20	15	32	-	2222	133	2 1/2"	-	46
SS 615/33	-	20	15	33	-	2282	133	2 1/2"	-	47
SS 615/34	-	25	18,5	34,0	-	2343	133	2 1/2"	-	48
SS 615/35	-	25	18,5	35,0	-	2403	133	2 1/2"	-	49
SS 615/36	-	25	18,5	36,0	-	2464	133	2 1/2"	-	51
SS 615/37	-	25	18,5	37,0	-	2524	133	2 1/2"	-	52
SS 615/38	-	25	18,5	38,0	-	2585	133	2 1/2"	-	53
SS 615/39	-	25	18,5	39,0	-	2645	133	2 1/2"	-	54
SS 615/40	-	25	18,5	40,0	-	2706	133	2 1/2"	-	55

MODELO	MOTOR			m³/h	0	10	11	12	13	14	15	16	17	18	19	
	4" HP	6" HP	kW		l / seg	0,00	2,78	3,06	3,33	3,61	3,89	4,17	4,44	4,72	5,00	5,28
					gpm	0	44	48	53	57	62	66	70	75	79	84
SS 615/21	-	15	11	CARGA DINÁMICA TOTAL (m)	252	205	195	188	182	178	168	161	153	142	132	
SS 615/22	-	15	11		264	215	204	197	191	187	176	169	160	149	138	
SS 615/23	-	15	11		276	225	213	206	200	195	184	177	167	156	144	
SS 615/24	-	15	11		288	235	223	215	208	204	192	184	175	163	151	
SS 615/25	-	15	11		300	245	232	224	217	212	200	192	182	170	157	
SS 615/26	-	20	15		312	254	241	233	226	221	208	200	189	176	163	
SS 615/27	-	20	15		324	264	251	242	234	229	216	207	197	183	170	
SS 615/28	-	20	15		336	274	260	251	243	238	224	215	204	190	176	
SS 615/29	-	20	15		348	284	269	260	252	246	232	223	211	197	182	
SS 615/30	-	20	15		360	294	279	269	261	255	240	231	219	204	189	
SS 615/31	-	20	15		372	303	288	278	269	263	248	238	226	210	195	
SS 615/32	-	20	15		384	313	297	287	278	272	256	246	233	217	201	
SS 615/33	-	20	15		396	323	306	296	287	280	264	254	240	224	207	
SS 615/34	-	25	18,5		408	333	316	305	295	289	272	261	248	231	214	
SS 615/35	-	25	18,5		420	343	325	314	304	297	280	269	255	238	220	
SS 615/36	-	25	18,5		432	353	334	323	313	306	288	277	262	244	226	
SS 615/37	-	25	18,5		444	362	344	332	321	314	296	284	270	251	233	
SS 615/38	-	25	18,5		456	372	353	341	330	323	304	292	277	258	239	
SS 615/39	-	25	18,5		468	382	362	350	339	331	312	300	284	265	245	
SS 615/40	-	25	18,5		480	392	372	359	348	340	320	308	292	272	252	

Fecha 03/2016 | Rev 01

Franklin Electric reserva el derecho a modificar productos sin previo aviso.

SS 615



BOMBAS DE ACERO INOXIDABLE
50 Hz

Curvas de Rendimiento - 21 a 40 etapas

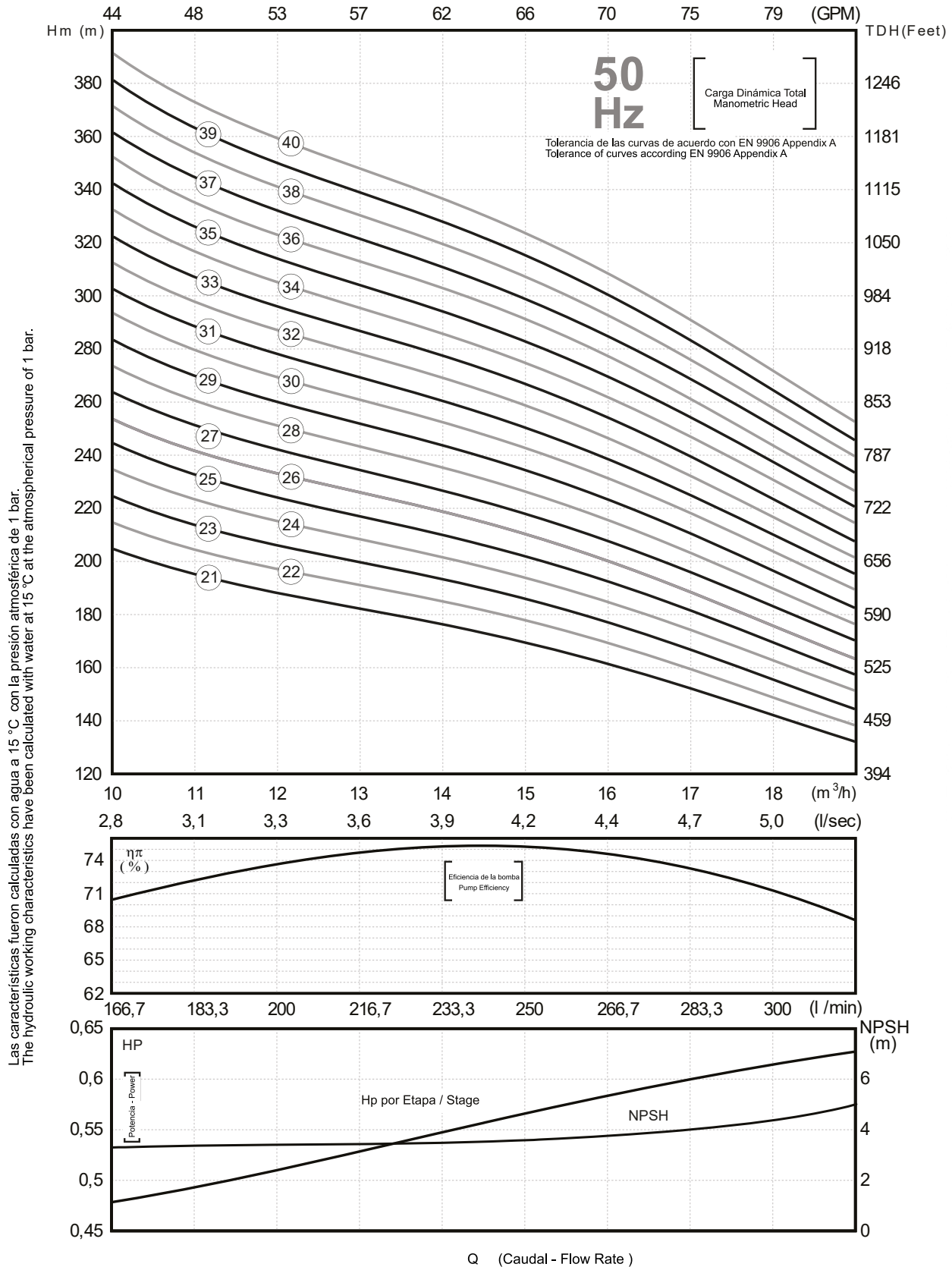

Desempeño de las curvas están basadas en la viscosidad $\nu = 1\text{mm}^2/\text{s}$ y densidad $\rho = 1000\text{ kg/m}^3$
Performance curves are based on the kinematic viscosity $\nu = 1\text{mm}^2/\text{s}$ and density $\rho = 1000\text{ kg/m}^3$

SS 624



**BOMBAS DE ACERO
INOXIDABLE**
50 Hz

Especificaciones

- Rango de operación en 50hz: Q = 15 m³/h - 36 m³/h
- Descarga: 3" con hilo en descarga 11 TPI
- Tipo del impulsor: flujo mixto
- Sentido de rotación: anti horaria
- Conexión: según estándar NEMA
- Diámetro del eje: 22mm
- Diámetro máximo de la bomba: 133mm (incluyendo guarda cable)
- Estándares de seguridad y fabricación:
 - TS 11146:2014
 - EN 809:1998+A1+2009+AC:2010

- Líquido a bombear: agua limpia
- Paso máximo de sólidos: 2 mm
- Concentración máxima de sólidos: 50 PPM
- Nivel mínimo de líquido (NPSH): 800mm desde el fondo de la ranura de succión

2006/42/EC
EN ISO 12100:2010

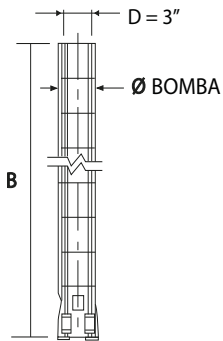

MODELO	MOTOR			ETAPAS	DIMENSIONES (mm)				P	
	4" HP	6" HP	kW		6"-4"	6"-6"	ø BOMBA	ø D	BOMBA	
					B	B			6"-4"	6"-6"
SS 624/01	0,75	-	0,55	1	364	-	133	3"	7	-
SS 624/02	1,5	-	1,1	2	460	-	133	3"	8	-
SS 624/03	2	-	1,5	3	556	-	133	3"	10	-
SS 624/04	3	-	2,2	4	652	-	133	3"	12	-
SS 624/05	4	-	3	5	748	-	133	3"	14	-
SS 624/06	4	-	3	6	844	-	133	3"	16	-
SS 624/07	5,5	5,5	4	7	940	940	133	3"	17	19
SS 624/08	5,5	5,5	4	8	1036	1036	133	3"	19	20,5
SS 624/09	7,5	7,5	5,5	9	1132	1132	133	3"	21	22
SS 624/10	7,5	7,5	5,5	10	1228	1228	133	3"	23	23,5
SS 624/11	7,5	7,5	5,5	11	1324	1324	133	3"	24	25
SS 624/12	10	10	7,5	12	1420	1420	133	3"	26	26,5
SS 624/13	10	10	7,5	13	1516	1516	133	3"	28	28
SS 624/14	10	10	7,5	14	1612	1612	133	3"	30	29,5
SS 624/15	10	10	7,5	15	1708	1708	133	3"	31	31
SS 624/16	-	12,5	9	16	-	1804	133	3"	-	32,5
SS 624/17	-	12,5	9	17	-	1900	133	3"	-	34
SS 624/18	-	12,5	9	18	-	1996	133	3"	-	35,5

MODELO	MOTOR			m ³ /h	0	15	18	21	24	27	30	33	36	
	4" HP	6" HP	kW		l / seg	0,00	4,17	5,00	5,83	6,67	7,50	8,33	9,17	10,00
					gpm	0	66	79	92	106	119	132	145	159
SS 624/01	0,75	-	0,55	CARGA DINÁMICA TOTAL (m)	8	7	7	6	6	5	4	3	2	
SS 624/02	1,5	-	1,1		16	14	14	13	12	10	8	6	4	
SS 624/03	2	-	1,5		23	21	20	19	17	15	12	9	6	
SS 624/04	3	-	2,2		31	28	27	25	23	20	17	12	8	
SS 624/05	4	-	3		39	36	34	32	29	25	21	16	11	
SS 624/06	4	-	3		47	43	41	38	35	30	25	19	13	
SS 624/07	5,5	5,5	4		55	50	47	45	41	35	29	22	15	
SS 624/08	5,5	5,5	4		62	57	54	51	46	40	33	25	17	
SS 624/09	7,5	7,5	5,5		70	64	61	57	52	46	37	28	19	
SS 624/10	7,5	7,5	5,5		78	71	68	64	58	51	41	31	21	
SS 624/11	7,5	7,5	5,5		86	78	74	70	64	56	46	34	23	
SS 624/12	10	10	7,5		94	85	81	76	70	61	50	37	25	
SS 624/13	10	10	7,5		101	92	88	83	75	66	54	41	27	
SS 624/14	10	10	7,5		109	99	95	89	81	71	58	44	30	
SS 624/15	10	10	7,5		117	107	101	95	87	76	62	47	32	
SS 624/16	-	12,5	9,2		125	114	108	102	93	81	66	50	34	
SS 624/17	-	12,5	9,2		133	121	115	108	99	86	70	53	36	
SS 624/18	-	12,5	9,2		140	128	122	114	104	91	75	56	38	

SS 624



**BOMBAS DE ACERO
INOXIDABLE**
50 Hz

Curvas de Rendimiento - 01 a 18 etapas

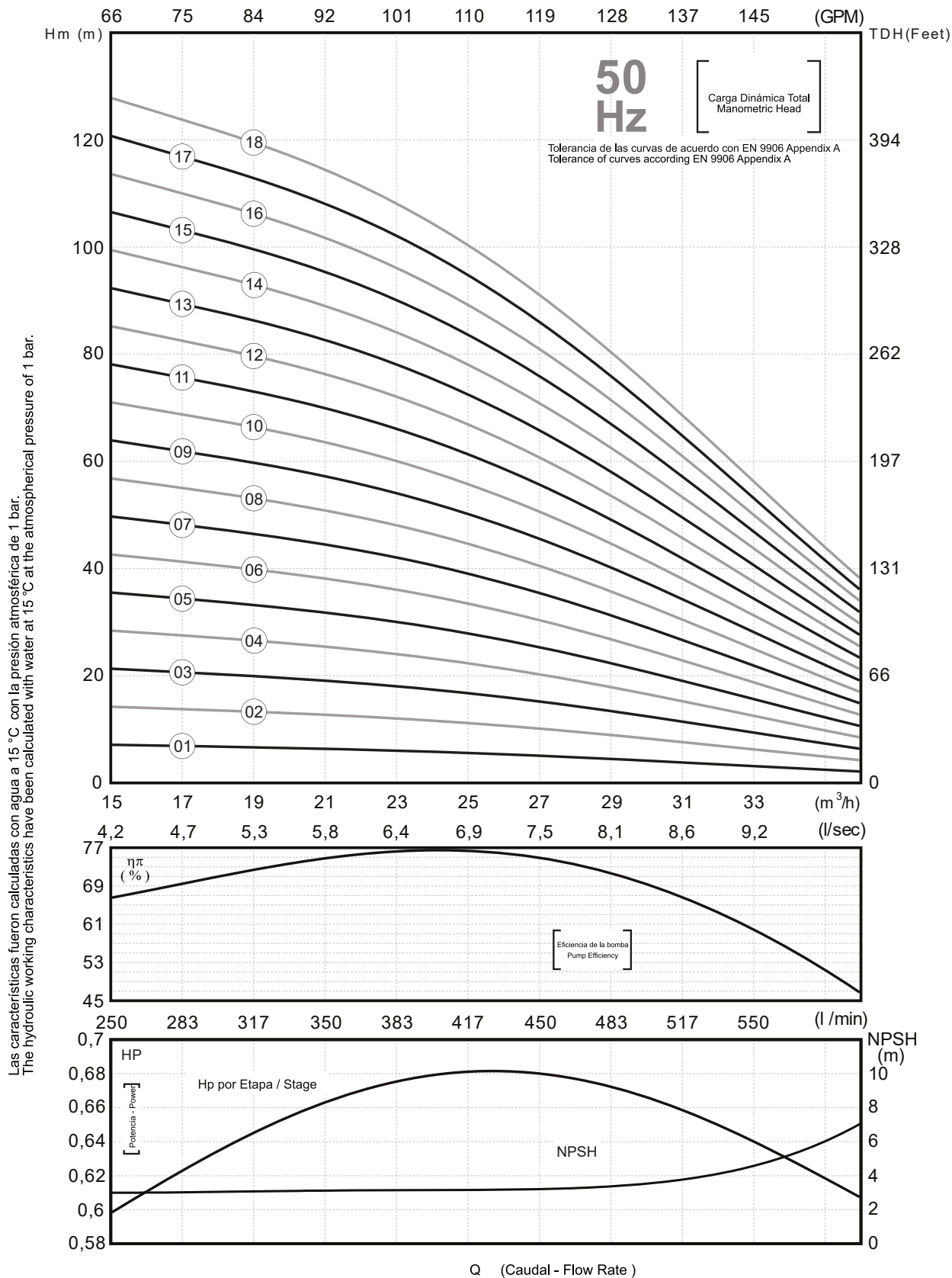

Desempeño de las curvas están basadas en la viscosidad $\nu = 1\text{mm}^2/\text{s}$ y densidad $\rho = 1000\text{ kg/m}^3$
Performance curves are based on the kinematic viscosity $\nu = 1\text{mm}^2/\text{s}$ and density $\rho = 1000\text{ kg/m}^3$

SS 624



**BOMBAS DE ACERO
INOXIDABLE**
50 Hz

Especificaciones

- Rango de operación en 50hz: Q = 15 m³/h - 36 m³/h
 - Descarga: 3" con hilo en descarga 11 TPI
 - Tipo del impulsor: flujo mixto
 - Sentido de rotación: anti horaria
 - Conexión: según estándar NEMA
 - Diámetro del eje: 22mm
 - Diámetro máximo de la bomba: 133mm (incluyendo guarda cable)
 - Líquido a bombear: agua limpia
 - Paso máximo de sólidos: 2 mm
 - Concentración máxima de sólidos: 50 PPM
 - Nivel mínimo de líquido (NPSH): 800mm desde el fondo de la ranura de succión
- Estándares de seguridad y fabricación:
- TS 11146:2014
 - EN 809:1998+A1+2009+AC:2010
- 2006/42/EC
EN ISO 12100:2010

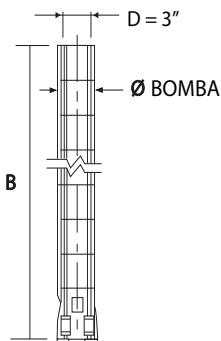

MODELO	MOTOR		ETAPAS	DIMENSIONES (mm)				BOMBA
	6" HP	kW		6"-6"	6"-8"	Ø BOMBA	Ø D	
				B	B			6"-6"
SS 624/19	15	11	19	2092	-	133	3"	37
SS 624/20	15	11	20	2188	-	133	3"	38,5
SS 624/21	15	11	21	2300	-	133	3"	40,929
SS 624/22	15	11	22	2396	-	133	3"	42,429
SS 624/23	20	15	23	2492	-	133	3"	43,929
SS 624/24	20	15	24	2588	-	133	3"	45,429
SS 624/25	20	15	25	2684	-	133	3"	46,929
SS 624/26	20	15	26	2780	-	133	3"	48,429
SS 624/27	20	15	27	2876	-	133	3"	49,929
SS 624/28	20	15	28	2972	-	133	3"	51,429
SS 624/29	20	15	29	3068	-	133	3"	52,929
SS 624/30	25	18,5	30	3164	-	133	3"	54,429
SS 624/31	25	18,5	31	3260	-	133	3"	55,929
SS 624/32	25	18,5	32	3356	-	133	3"	57,429
SS 624/33	25	18,5	33	3452	-	133	3"	58,929
SS 624/34	25	18,5	34	3548	-	133	3"	60,429
SS 624/35	25	18,5	35	3644	-	133	3"	61,929
SS 624/36	25	18,5	36	3740	-	133	3"	63,429
SS 624/37	30	22	37	3836	3864,5	133	3"	64,929
SS 624/38	30	22	38	3932	3960,5	133	3"	66,429

MODELO	MOTOR		m ³ /h	0	15	18	21	24	27	30	33	36	
	6" HP	kW		l / seg	0,00	4,17	5,00	5,83	6,67	7,50	8,33	9,17	10,00
				gpm	0	66	79	92	106	119	132	145	159
SS 624/19	15	11	CARGA DINÁMICA TOTAL (m)	148	135	128	121	110	96	79	59	40	
SS 624/20	15	11		156	142	135	127	116	101	83	62	42	
SS 624/21	15	11		164	149	142	134	122	106	87	66	44	
SS 624/22	15	11		172	156	149	140	127	111	91	69	47	
SS 624/23	20	15		179	163	156	146	133	116	95	72	49	
SS 624/24	20	15		187	170	162	153	139	121	100	75	51	
SS 624/25	20	15		195	178	169	159	145	127	104	78	53	
SS 624/26	20	15		203	185	176	165	151	132	108	81	55	
SS 624/27	20	15		211	192	183	172	156	137	112	84	57	
SS 624/28	20	15		218	199	189	178	162	142	116	87	59	
SS 624/29	20	15		226	206	196	184	168	147	120	91	61	
SS 624/30	25	18,5		234	213	203	191	174	152	124	94	63	
SS 624/31	25	18,5		242	220	210	197	180	157	129	97	66	
SS 624/32	25	18,5		249	227	216	203	185	162	133	100	68	
SS 624/33	25	18,5		257	234	223	210	191	167	137	103	70	
SS 624/34	25	18,5		265	241	230	216	197	172	141	106	72	
SS 624/35	25	18,5		273	249	237	223	203	177	145	109	74	
SS 624/36	25	18,5		281	256	243	229	209	182	149	112	76	
SS 624/37	30	22	288	263	250	235	214	187	153	116	78		
SS 624/38	30	22	296	270	257	242	220	192	158	119	80		

Fecha 03/2016 | Rev 01

Franklin Electric reserva el derecho a modificar productos sin previo aviso.

SS 624



**BOMBAS DE ACERO
INOXIDABLE**
50 Hz

Curvas de Rendimiento - 19 a 38 etapas

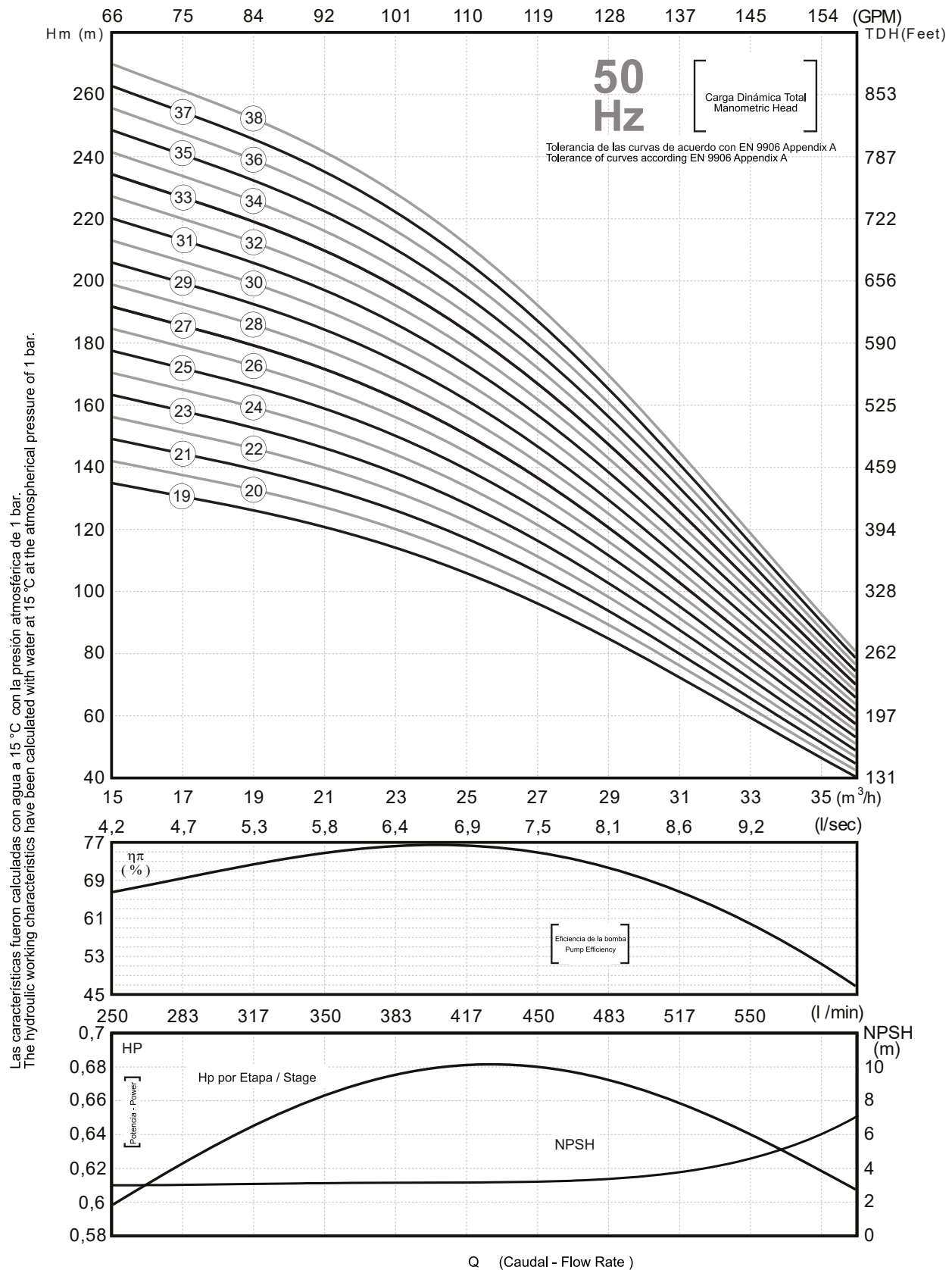

Desempeño de las curvas están basadas en la viscosidad $\nu = 1\text{mm}^2/\text{s}$ y densidad $\rho = 1000\text{kg}/\text{m}^3$
Performance curves are based on the kinematic viscosity $\nu = 1\text{mm}^2/\text{s}$ and density $\rho = 1000\text{kg}/\text{m}^3$

SS 630



**BOMBAS DE ACERO
INOXIDABLE**
50 Hz

Curvas de Rendimiento - 01 a 37 etapas

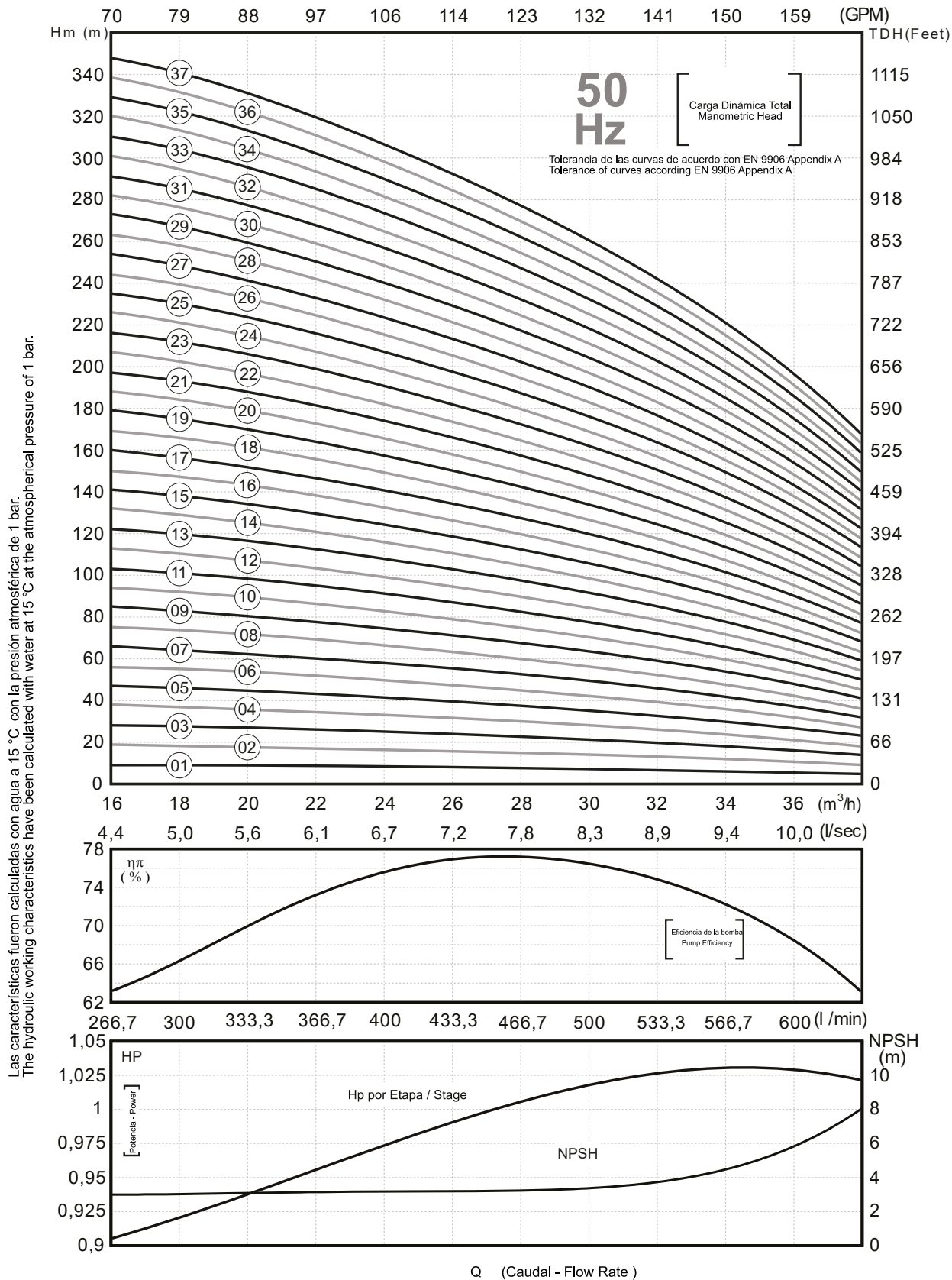

Desempeño de las curvas están basadas en la viscosidad $\nu = 1\text{mm}^2/\text{s}$ y densidad $\rho = 1000\text{ kg/m}^3$
Performance curves are based on the kinematic viscosity $\nu = 1\text{mm}^2/\text{s}$ and density $\rho = 1000\text{ kg/m}^3$

SS 636



**BOMBAS DE ACERO
INOXIDABLE**
50 Hz

Especificaciones

- Rango de operación en 50hz: Q = 24 m³/h - 51 m³/h
- Descarga: 3" con hilo en descarga 11 TPI
- Tipo del impulsor: flujo mixto
- Sentido de rotación: anti horaria
- Conexión: según estándar NEMA
- Diámetro del eje: 22mm
- Diámetro máximo de la bomba: 149mm (incluyendo guarda cable)
- Estándares de seguridad y fabricación:
 - TS 11146:2014
 - EN 809:1998+A1+2009+AC:2010

- Líquido a bombear: agua limpia
- Paso máximo de sólidos: 2 mm
- Concentración máxima de sólidos: 50 PPM
- Nivel mínimo de líquido (NPSH): 800mm desde el fondo de la ranura de succión

2006/42/EC
EN ISO 12100:2010

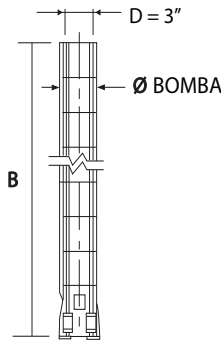

MODELO	MOTOR				ETAPAS	DIMENSIONES (mm)					PESO (kg)		
	4" HP	6" HP	8" HP	kW		4"		8"	Ø BOMBA		BOMBA		
						B	B		Ø	Ø	6"-4"	6"-6"	6"-8"
SS 636/01	1,5	-	-	1,1	1	385	-	-	145	3"	7	-	-
SS 636/02	3	-	-	2,2	2	498	-	-	145	3"	9	-	-
SS 636/03	5,5	5,5	-	4	3	611	611	-	145	3"	11	11	-
SS 636/04	5,5	5,5	-	4	4	724	724	-	145	3"	14	14	-
SS 636/05	7,5	7,5	-	5,5	5	837	837	-	145	3"	16	16	-
SS 636/06	10	10	-	7,5	6	950	950	-	145	3"	18	18	-
SS 636/07	10	10	-	7,5	7	1063	1063	-	145	3"	20	20	-
SS 636/08	-	12,5	-	9,2	8	-	1176	-	145	3"	-	22	-
SS 636/09	-	15	-	11	9	-	1289	-	145	3"	-	24	-
SS 636/10	-	15	-	11	10	-	1402	-	145	3"	-	26	-
SS 636/11	-	20	-	15	11	-	1515	-	145	3"	-	29	-
SS 636/12	-	20	-	15	12	-	1628	-	145	3"	-	31	-
SS 636/13	-	20	-	15	13	-	1741	-	145	3"	-	33	-
SS 636/14	-	20	-	15	14	-	1854	-	145	3"	-	35	-
SS 636/15	-	25	-	18,5	15	-	1967	-	145	3"	-	37	-
SS 636/16	-	25	-	18,5	16	-	2080	-	145	3"	-	39	-
SS 636/17	-	25	-	18,5	17	-	2193	-	145	3"	-	41	-
SS 636/18	-	25	-	18,5	18	-	2306	-	145	3"	-	43	-
SS 636/19	-	30	-	22	19	-	2419	2419	145	3"	-	45	-
SS 636/20	-	30	-	22	20	-	2548	2548	145	3"	-	48	-
SS 636/21	-	30	-	22	21	-	2661	2661	145	3"	-	50	-
SS 636/22	-	40	40	30	22	-	2774	2774	145	3"	-	53	53
SS 636/23	-	40	40	30	23	-	2887	2887	145	3"	-	55	55
SS 636/24	-	40	40	30	24	-	3000	3000	145	3"	-	57	57
SS 636/25	-	40	40	30	25	-	3113	3113	145	3"	-	59	59
SS 636/26	-	40	40	30	26	-	3226	3226	145	3"	-	61	61
SS 636/27	-	40	40	30	27	-	3339	3339	145	3"	-	63	63
SS 636/28	-	40	40	30	28	-	3452	3452	145	3"	-	65	65
SS 636/29	-	40	40	30	29	-	3565	3565	145	3"	-	67	67

MODELO	MOTOR				m³/h	CARGA DINÁMICA TOTAL (m)																															
	4" HP	6" HP	8" HP	kW		l / seg	0 24 27 30 33 36 39 42 45 48 51																														
							gpm																														
SS 636/01	1,5	-	-	1,1	0	0,00	6,67	7,50	8,33	9,17	10,00	10,83	11,67	12,50	13,33	14,17	0	106	119	132	145	159	172	185	198	211	225										
SS 636/02	3	-	-	2,2	11	10	9	9	8	8	8	7	6	6	5	23	19	19	18	17	16	15	14	13	12	11	34	29	28	26	25	24	23	21	19	18	16
SS 636/03	5,5	5,5	-	4	46	39	37	35	34	32	30	28	26	24	21	57	49	46	44	42	40	38	35	32	30	26	68	58	56	53	51	48	45	42	39	36	32
SS 636/04	5,5	5,5	-	4	80	68	65	61	59	56	53	49	45	41	37	91	78	74	70	68	64	60	56	52	47	42	103	87	84	79	76	71	68	63	58	53	48
SS 636/05	7,5	7,5	-	5,5	114	97	93	88	84	79	75	70	65	59	53	126	107	102	97	93	87	83	77	71	65	58	137	116	112	105	101	95	90	84	78	71	63
SS 636/06	10	10	-	7,5	148	126	121	114	110	103	98	91	84	77	69	160	136	130	123	118	111	105	99	91	83	74	171	146	139	132	127	119	113	106	97	89	79
SS 636/07	10	10	-	7,5	183	155	149	140	135	127	120	113	104	95	85	194	165	158	149	144	135	128	120	110	101	90	205	175	167	158	152	143	135	127	117	107	95
SS 636/08	-	12,5	-	9,2	217	184	177	167	161	151	143	134	123	113	100	228	194	186	176	169	159	150	141	130	119	106	240	204	195	184	177	167	158	148	136	124	111
SS 636/09	-	15	-	11	251	214	205	193	186	175	165	155	143	130	116	274	233	223	211	203	191	180	169	156	142	127	285	243	232	219	211	199	188	176	162	148	132
SS 636/10	-	15	-	11	297	252	242	228	220	206	195	183	169	154	137	308	262	251	237	228	214	203	190	175	160	143	320	272	260	246	237	222	210	197	182	166	148
SS 636/11	-	20	-	15	331	282	270	255	245	230	218	204	188	172	153	331	282	270	255	245	230	218	204	188	172	153	331	282	270	255	245	230	218	204	188	172	153

SS 636



BOMBAS DE ACERO INOXIDABLE
50 Hz

Curvas de Rendimiento - 01 a 29 etapas

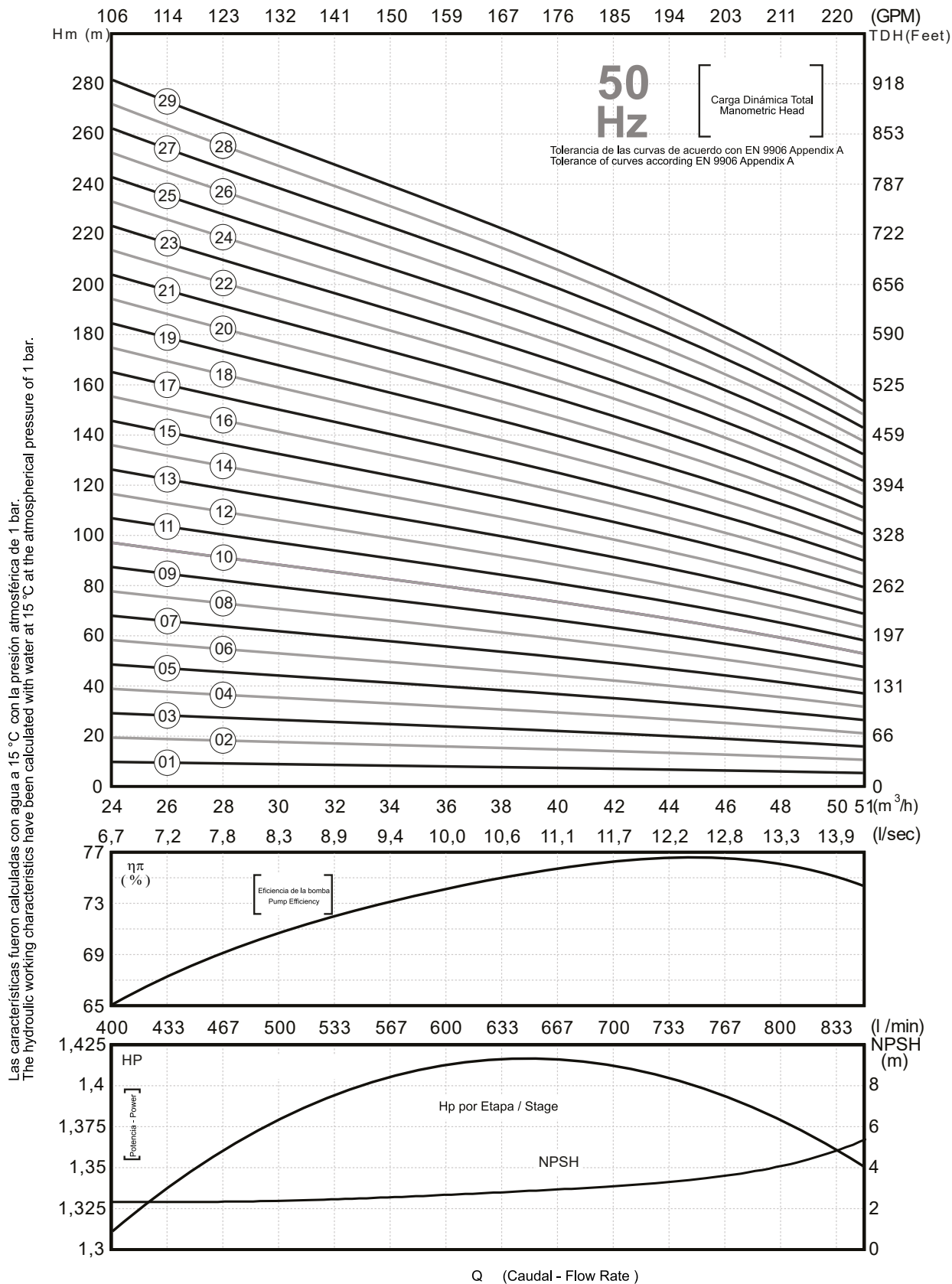

Desempeño de las curvas están basadas en la viscosidad $\nu = 1\text{mm}^2/\text{s}$ y densidad $\rho = 1000\text{ kg/m}^3$
Performance curves are based on the kinematic viscosity $\nu = 1\text{mm}^2/\text{s}$ and density $\rho = 1000\text{ kg/m}^3$



Especificaciones

- Rango de operación en 50hz: Q = 36 m³/h - 58 m³/h
- Descarga: 3" con hilo en descarga 11 TPI
- Tipo del impulsor: flujo mixto
- Sentido de rotación: anti horaria
- Conexión: según estándar NEMA
- Diámetro del eje: 22mm
- Diámetro máximo de la bomba: 149mm (incluyendo guarda cable)
- Estándares de seguridad y fabricación:
 - TS 11146:2014
 - EN 809:1998+A1+2009+AC:2010

- Líquido a bombear: agua limpia
- Paso máximo de sólidos: 2 mm
- Concentración máxima de sólidos: 50 PPM
- Nivel mínimo de líquido (NPSH): 800mm desde el fondo de la ranura de succión

2006/42/EC
EN ISO 12100:2010

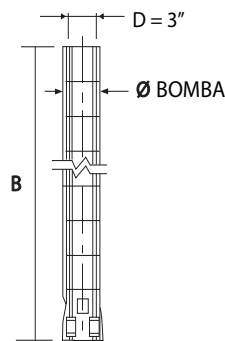

MODELO	MOTOR				ETAPAS	DIMENSIONES (mm)					PESO (kg)		
	4" HP	6" HP	8" HP	kW		4"	6"	8"	Ø BOMBA	Ø D	BOMBA		
											6"-4"	6"-6"	6"-8"
SS 642/01	2	-	-	1,5	1	385	-	-	145	3"	7	-	-
SS 642/02	4	-	-	3	2	498	-	-	145	3"	9	-	-
SS 642/03	7,5	7,5	-	5,5	3	611	611	-	145	3"	11	12	-
SS 642/04	10	10	-	7,5	4	724	724	-	145	3"	14	14	-
SS 642/05	10	10	-	7,5	5	837	837	-	145	3"	16	16	-
SS 642/06	-	12,5	-	9	6	-	950	-	145	3"	-	18	-
SS 642/07	-	15	-	11	7	-	1063	-	145	3"	-	20	-
SS 642/08	-	20	-	15	8	-	1176	-	145	3"	-	22	-
SS 642/09	-	20	-	15	9	-	1289	-	145	3"	-	24	-
SS 642/10	-	20	-	15	10	-	1402	-	145	3"	-	26	-
SS 642/11	-	25	-	18,5	11	-	1515	-	145	3"	-	29	-
SS 642/12	-	25	-	18,5	12	-	1628	-	145	3"	-	31	-
SS 642/13	-	30	-	22	13	-	1741	1770	145	3"	-	33	-
SS 642/14	-	30	-	22	14	-	1854	1883	145	3"	-	35	-
SS 642/15	-	30	-	22	15	-	1967	1996	145	3"	-	37	-
SS 642/16	-	40	40	30	16	-	2080	2109	145	3"	-	39	42
SS 642/17	-	40	40	30	17	-	2193	2222	145	3"	-	41	44
SS 642/18	-	40	40	30	18	-	2306	2335	145	3"	-	43	46
SS 642/19	-	40	40	30	19	-	2419	2448	145	3"	-	45	49
SS 642/20	-	40	40	30	20	-	2548	2577	145	3"	-	48	51
SS 642/21	-	50	50	37	21	-	2661	2690	145	3"	-	50	53
SS 642/22	-	50	50	37	22	-	2774	2803	145	3"	-	53	56
SS 642/23	-	50	50	37	23	-	2887	2916	145	3"	-	55	58
SS 642/24	-	50	50	37	24	-	3000	3029	145	3"	-	57	60
SS 642/25	-	50	50	37	25	-	3113	3142	145	3"	-	59	62

MODELO	MOTOR				m³/h	CARGA DINÁMICA TOTAL (m)														
	4" HP	6" HP	8" HP	kW		0	36	38	40	42	44	46	48	50	52	54	56	58		
						l / seg	10,00	10,56	11,11	11,67	12,22	12,78	13,33	13,89	14,44	15,00	15,56	16,11		
SS 642/01	2	-	-	1,5	0	0,00	10,00	10,56	11,11	11,67	12,22	12,78	13,33	13,89	14,44	15,00	15,56	16,11		
SS 642/02	4	-	-	3	13	10	10	10	9	9	9	8	8	8	8	7	7	6		
SS 642/03	7,5	7,5	-	5,5	26	20	19	19	19	18	18	17	17	16	16	15	14	12		
SS 642/04	10	10	-	7,5	39	29	29	28	27	26	26	25	24	23	22	20	19			
SS 642/05	10	10	-	7,5	52	39	38	37	36	35	34	33	32	31	29	27	25			
SS 642/06	-	12,5	-	9	65	49	48	47	46	44	43	42	40	39	37	34	31			
SS 642/07	-	15	-	11	78	59	57	56	55	53	51	50	48	47	44	41	37			
SS 642/08	-	20	-	15	91	69	67	65	64	62	60	58	56	55	51	48	43			
SS 642/09	-	20	-	15	104	78	76	74	73	70	68	66	64	62	58	54	50			
SS 642/10	-	20	-	15	117	88	86	84	82	79	77	75	72	70	66	61	56			
SS 642/11	-	25	-	18,5	130	98	95	93	91	88	85	83	80	78	73	68	62			
SS 642/12	-	25	-	18,5	143	108	105	102	100	97	94	91	88	86	80	75	68			
SS 642/13	-	30	-	22	156	118	114	112	109	106	102	100	96	94	88	82	74			
SS 642/14	-	30	-	22	169	127	124	121	118	114	111	108	104	101	95	88	81			
SS 642/15	-	30	-	22	182	137	133	130	127	123	119	116	112	109	102	95	87			
SS 642/16	-	40	40	30	195	147	143	140	137	132	128	125	120	117	110	102	93			
SS 642/17	-	40	40	30	208	157	152	149	146	141	136	133	128	125	117	109	99			
SS 642/18	-	40	40	30	221	167	162	158	155	150	145	141	136	133	124	116	105			
SS 642/19	-	40	40	30	234	176	171	167	164	158	153	149	144	140	131	122	112			
SS 642/20	-	40	40	30	247	186	181	177	173	167	162	158	152	148	139	129	118			
SS 642/21	-	50	50	37	260	196	190	186	182	176	170	166	160	156	146	136	124			
SS 642/22	-	50	50	37	273	206	200	195	191	185	179	174	168	164	153	143	130			
SS 642/23	-	50	50	37	286	216	209	205	200	194	187	183	176	172	161	150	136			
SS 642/24	-	50	50	37	299	225	219	214	209	202	196	191	184	179	168	156	143			
SS 642/25	-	50	50	37	312	235	228	223	218	211	204	199	192	187	175	163	149			
SS 642/25	-	50	50	37	325	245	238	233	228	220	213	208	200	195	183	170	155			

SS 642



**BOMBAS DE ACERO
INOXIDABLE**
50 Hz

Curvas de Rendimiento - 01 a 25 etapas

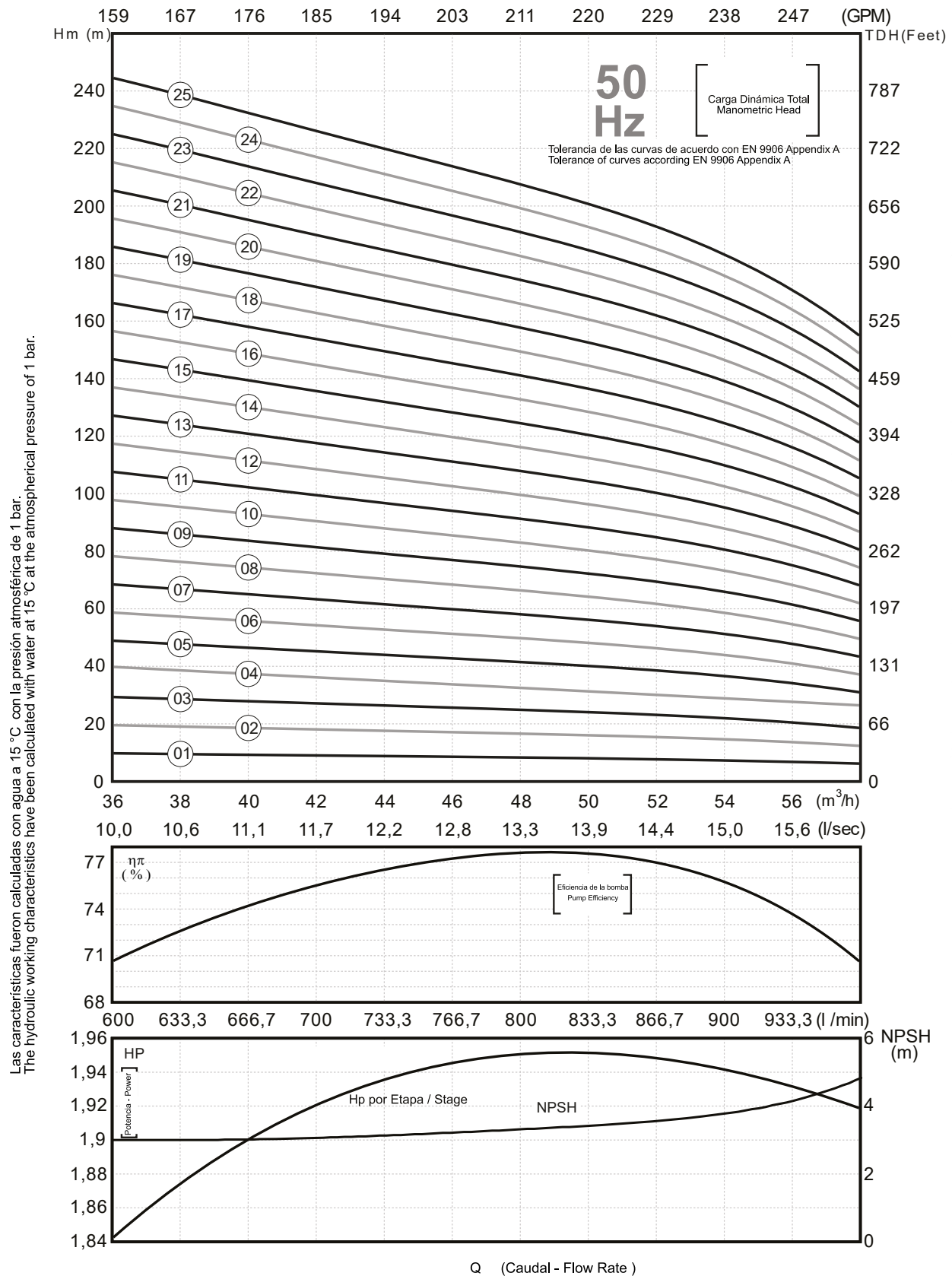

Desempeño de las curvas están basadas en la viscosidad $\nu = 1\text{mm}^2/\text{s}$ y densidad $\rho = 1000\text{ kg/m}^3$
Performance curves are based on the kinematic viscosity $\nu = 1\text{mm}^2/\text{s}$ and density $\rho = 1000\text{ kg/m}^3$

SS 660



**BOMBAS DE ACERO
INOXIDABLE**
50 Hz

Especificaciones

- Rango de operación en 50hz: Q = 30 m³/h - 78 m³/h
 - Descarga: 4" con hilo en descarga 11 TPI
 - Tipo del impulsor: flujo mixto
 - Sentido de rotación: anti horaria
 - Conexión: según estándar NEMA
 - Diámetro del eje: 22mm
 - Diámetro máximo de la bomba: 149mm (incluyendo guarda cable)
- Estándares de seguridad y fabricación:
 - TS 11146:2014
 - EN 809:1998+A1+2009+AC:2010

2006/42/EC
EN ISO 12100:2010

- Líquido a bombear: agua limpia
- Paso máximo de sólidos: 2 mm
- Concentración máxima de sólidos: 50 PPM
- Nivel mínimo de líquido (NPSH): 800mm desde el fondo de la ranura de succión

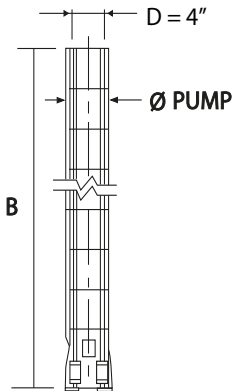

MODELO	MOTOR				ETAPAS	DIMENSIONES (mm)					PESO (kg)		
	4" HP	6" HP	8" HP	kW		B	B	B	ø BOMBA	ø D	BOMBA		
											6"-4"	6"-6"	6"-8"
SS 660/01	2	-	-	1,5	1	385	-	-	149	4"	7	-	-
SS 660/02	4	-	-	3	2	498	-	-	149	4"	9	-	-
SS 660/03	7,5	7,5	-	5,5	3	611	611	-	149	4"	12	12	-
SS 660/04	10	10	-	7,5	4	724	724	-	149	4"	14	14	-
SS 660/05	10	10	-	7,5	5	837	837	-	149	4"	16	16	-
SS 660/06	-	12,5	-	9	6	-	950	-	149	4"	-	18	-
SS 660/07	-	15	-	11	7	-	1063	-	149	4"	-	20	-
SS 660/08	-	15	-	11	8	-	1176	-	149	4"	-	22	-
SS 660/09	-	20	-	15	9	-	1289	-	149	4"	-	24	-
SS 660/10	-	20	-	15	10	-	1402	-	149	4"	-	26	-
SS 660/11	-	25	-	18,5	11	-	1515	-	149	4"	-	28	-
SS 660/12	-	25	-	18,5	12	-	1628	-	149	4"	-	30	-
SS 660/13	-	25	-	18,5	13	-	1741	-	149	4"	-	32	-
SS 660/14	-	30	-	22	14	-	1854	1883	149	4"	-	34	-
SS 660/15	-	30	-	22	15	-	1967	1996	149	4"	-	36	-
SS 660/16	-	40	40	30	16	-	2080	2109	149	4"	-	38	41
SS 660/17	-	40	40	30	17	-	2193	2222	149	4"	-	40	43
SS 660/18	-	40	40	30	18	-	2306	2335	149	4"	-	42	45
SS 660/19	-	40	40	30	19	-	2419	2448	149	4"	-	44	47
SS 660/20	-	40	40	30	20	-	2548	2577	149	4"	-	47	50
SS 660/21	-	40	40	30	21	-	2661	2690	149	4"	-	49	52
SS 660/22	-	50	50	37	22	-	2774	2803	149	4"	-	51	54
SS 660/23	-	50	50	37	23	-	2887	2916	149	4"	-	53	56
SS 660/24	-	50	50	37	24	-	3000	3029	149	4"	-	55	58
SS 660/25	-	50	50	37	25	-	3113	3142	149	4"	-	57	60

MODELO	MOTOR				m³/h	CARGA DINÁMICA TOTAL (m)													
	4" HP	6" HP	8" HP	kW		l / seg	0 30 36 42 48 54 60 66 72 78												
							0,00 8,33 10,00 11,67 13,33 15,00 16,67 18,33 20,00 21,67												
					gpm	0 132 159 185 211 238 264 291 317 343													
SS 660/01	2	-	-	1,5	11	10	9	9	8	8	7	6	5	4					
SS 660/02	4	-	-	3	22	20	19	18	17	15	13	11	9	7					
SS 660/03	7,5	7,5	-	5,5	33	30	28	27	25	23	20	17	14	11					
SS 660/04	10	10	-	7,5	44	40	37	36	33	30	27	23	19	14					
SS 660/05	10	10	-	7,5	52	51	47	43	40	36	32	28	23	17					
SS 660/06	-	12,5	-	9	61	61	56	50	47	43	38	32	27	20					
SS 660/07	-	15	-	11	70	71	65	58	54	49	43	37	31	23					
SS 660/08	-	15	-	11	79	81	74	65	61	55	49	42	35	26					
SS 660/09	-	20	-	15	88	91	84	73	68	61	54	47	39	29					
SS 660/10	-	20	-	15	105	101	93	83	77	69	61	53	44	33					
SS 660/11	-	25	-	18,5	123	111	102	93	86	77	68	59	49	37					
SS 660/12	-	25	-	18,5	141	121	112	103	95	85	75	65	54	41					
SS 660/13	-	25	-	18,5	158	131	121	113	104	93	82	71	59	45					
SS 660/14	-	30	-	22	176	141	130	123	113	101	89	77	64	50					
SS 660/15	-	30	-	22	194	152	140	133	122	109	100	83	69	54					
SS 660/16	-	40	40	30	202	162	149	141	130	117	103	89	74	57					
SS 660/17	-	40	40	30	210	172	158	150	138	125	110	95	79	61					
SS 660/18	-	40	40	30	218	182	167	159	146	132	117	100	84	65					
SS 660/19	-	40	40	30	226	192	177	167	155	140	124	106	89	69					
SS 660/20	-	40	40	30	234	202	186	176	163	147	131	112	94	73					
SS 660/21	-	40	40	30	242	212	195	185	171	155	137	118	99	77					
SS 660/22	-	50	50	37	250	222	205	193	179	163	144	124	104	81					
SS 660/23	-	50	50	37	259	232	214	202	187	170	151	130	109	84					
SS 660/24	-	50	50	37	267	242	223	211	196	178	158	136	114	88					
SS 660/25	-	50	50	37	275	253	233	219	204	185	165	142	119	92					

Fecha 03/2016 | Rev 01

Franklin Electric reserva el derecho a modificar productos sin previo aviso.

SS 660



**BOMBAS DE ACERO
INOXIDABLE**
50 Hz

Curvas de Rendimiento - 01 a 25 etapas

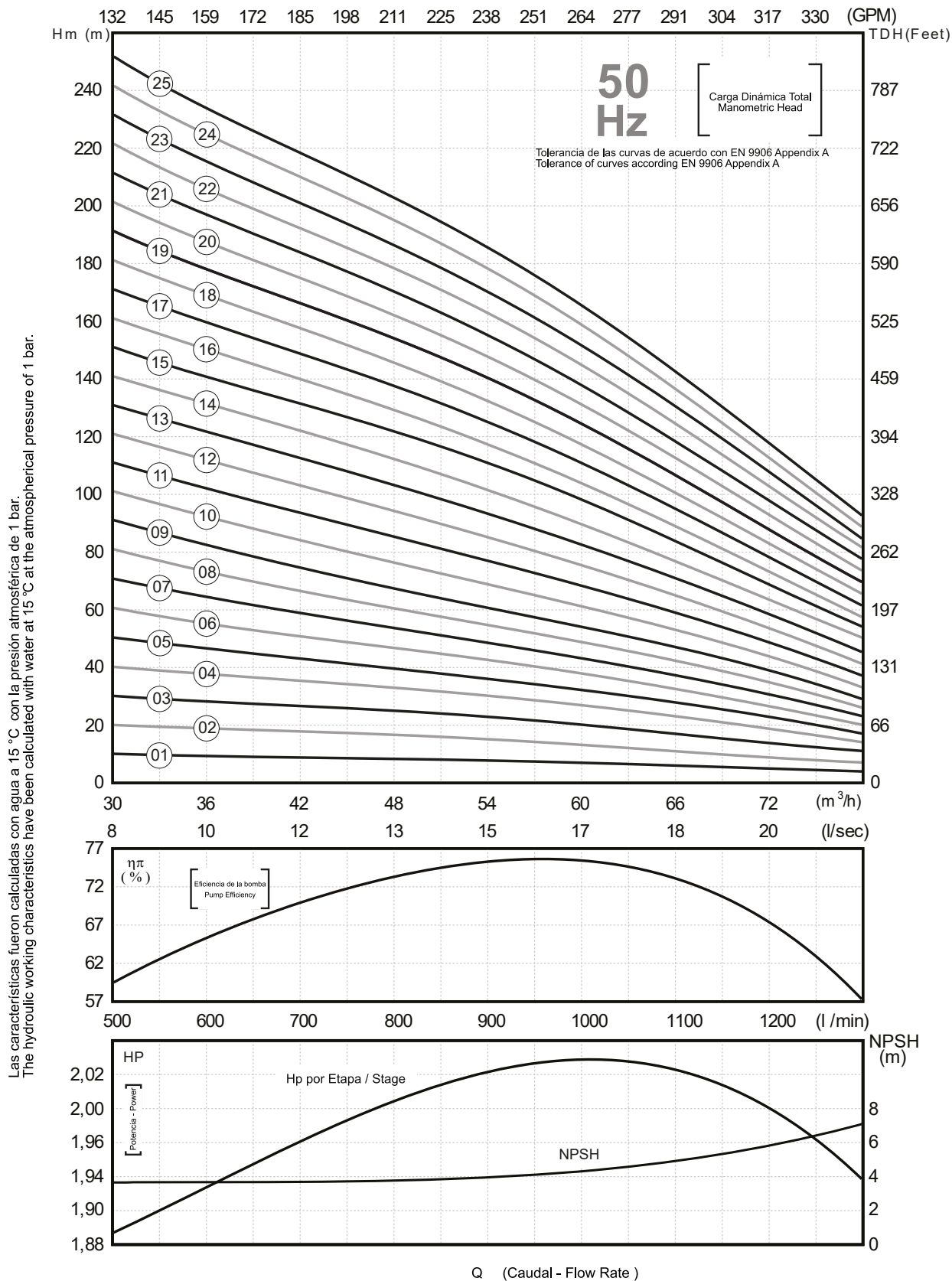

Desempeño de las curvas están basadas en la viscosidad $\nu = 1\text{mm}^2/\text{s}$ y densidad $\rho = 1000\text{ kg/m}^3$
Performance curves are based on the kinematic viscosity $\nu = 1\text{mm}^2/\text{s}$ and density $\rho = 1000\text{ kg/m}^3$

SS 675



**BOMBAS DE ACERO
INOXIDABLE**
50 Hz

Especificaciones

- Rango de operación en 50hz: Q = 42 m³/h - 96 m³/h
 - Descarga: 4" con hilo en descarga 11 TPI
 - Tipo del impulsor: flujo mixto
 - Sentido de rotación: anti horaria
 - Conexión: según estándar NEMA
 - Diámetro del eje: 22mm
 - Diámetro máximo de la bomba: 149mm (incluyendo guarda cable)
- Estándares de seguridad y fabricación:
- TS 11146:2014
 - EN 809:1998+A1+2009+AC:2010

2006/42/EC
EN ISO 12100:2010

- Líquido a bombear: agua limpia
- Paso máximo de sólidos: 2 mm
- Concentración máxima de sólidos: 50 PPM
- Nivel mínimo de líquido (NPSH): 800mm desde el fondo de la ranura de succión

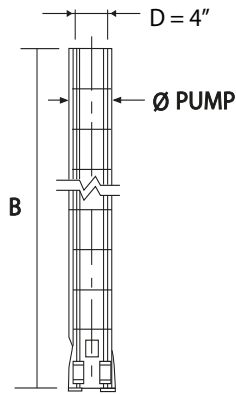

MODELO	MOTOR				ETAPAS	DIMENSIONES (mm)					PESO (kg)		
	4" HP	6" HP	8" HP	kW		4"	6"	8"	Ø BOMBA	Ø D	BOMBA		
						B	B	B			6"-4"	6"-6"	6"-8"
SS 675/01	4	-	-	3	1	439	-	-	149	4"	11	-	-
SS 675/02	7,5	7,5	-	5,5	2	580	580	-	149	4"	14	14	-
SS 675/03	10	10	-	7,5	3	721	721	-	149	4"	17	17	-
SS 675/04	-	15	-	11	4	-	862	-	149	4"	-	20	-
SS 675/05	-	20	-	15	5	-	1003	-	149	4"	-	23	-
SS 675/06	-	20	-	15	6	-	1144	-	149	4"	-	26	-
SS 675/07	-	25	-	18,5	7	-	1285	-	149	4"	-	29	-
SS 675/08	-	25	-	18,5	8	-	1426	-	149	4"	-	32	-
SS 675/09	-	30	-	22	9	-	1567	1596	149	4"	-	35	-
SS 675/10	-	40	40	30	10	-	1708	1737	149	4"	-	38	41
SS 675/11	-	40	40	30	11	-	1849	1878	149	4"	-	41	44
SS 675/12	-	40	40	30	12	-	1990	2019	149	4"	-	44	47
SS 675/13	-	50	50	37	13	-	2131	2160	149	4"	-	47	50
SS 675/14	-	50	50	37	14	-	2272	2301	149	4"	-	50	53
SS 675/15	-	50	50	37	15	-	2413	2442	149	4"	-	54	57
SS 675/16	-	60	60	45	16	-	2554	2583	149	4"	-	57	60
SS 675/17	-	60	60	45	17	-	2695	2724	149	4"	-	60	63
SS 675/18	-	60	60	45	18	-	2836	2865	149	4"	-	63	66

MODELO	MOTOR				m³/h	0	42	54	64	70	75	80	84	90	96	
	4" HP	6" HP	8" HP	kW		l / seg	0,00	11,67	15,00	17,78	19,44	20,83	22,22	23,33	25,00	26,67
						gpm	0	185	238	282	308	330	352	370	396	423
SS 675/01	4	-	-	3	CARGA DINÁMICA TOTAL (m)	16	11	11	10	9	8	7	7	6	4	
SS 675/02	7,5	7,5	-	5,5		32	23	21	20	19	17	15	13	11	9	
SS 675/03	10	10	-	7,5		49	34	32	30	28	25	22	20	17	13	
SS 675/04	-	15	-	11		65	45	43	40	37	33	30	27	22	17	
SS 675/05	-	20	-	15		81	56	53	49	47	41	37	34	28	21	
SS 675/06	-	20	-	15		97	68	64	59	56	50	45	40	33	26	
SS 675/07	-	25	-	18,5		113	79	74	69	65	58	52	47	39	30	
SS 675/08	-	25	-	18,5		130	90	85	79	74	66	60	54	45	34	
SS 675/09	-	30	-	22		146	102	96	89	84	75	67	60	50	39	
SS 675/10	-	40	40	30		162	113	106	99	93	83	74	67	56	43	
SS 675/11	-	40	40	30		178	124	117	109	102	91	82	74	61	47	
SS 675/12	-	40	40	30		194	135	128	119	112	99	89	81	67	51	
SS 675/13	-	50	50	37		210	147	138	128	121	108	97	87	72	56	
SS 675/14	-	50	50	37		227	158	149	138	130	116	104	94	78	60	
SS 675/15	-	50	50	37		243	169	160	148	140	124	112	101	84	64	
SS 675/16	-	60	60	45		259	180	170	158	149	133	119	107	89	69	
SS 675/17	-	60	60	45		275	192	181	168	158	141	127	114	95	73	
SS 675/18	-	60	60	45		291	203	191	178	167	149	134	121	100	77	

Fecha 03/2016 | Rev 01

Franklin Electric reserva el derecho a modificar productos sin previo aviso.

SS 675



**BOMBAS DE ACERO
INOXIDABLE**
50 Hz

Curvas de Rendimiento - 01 a 18 etapas

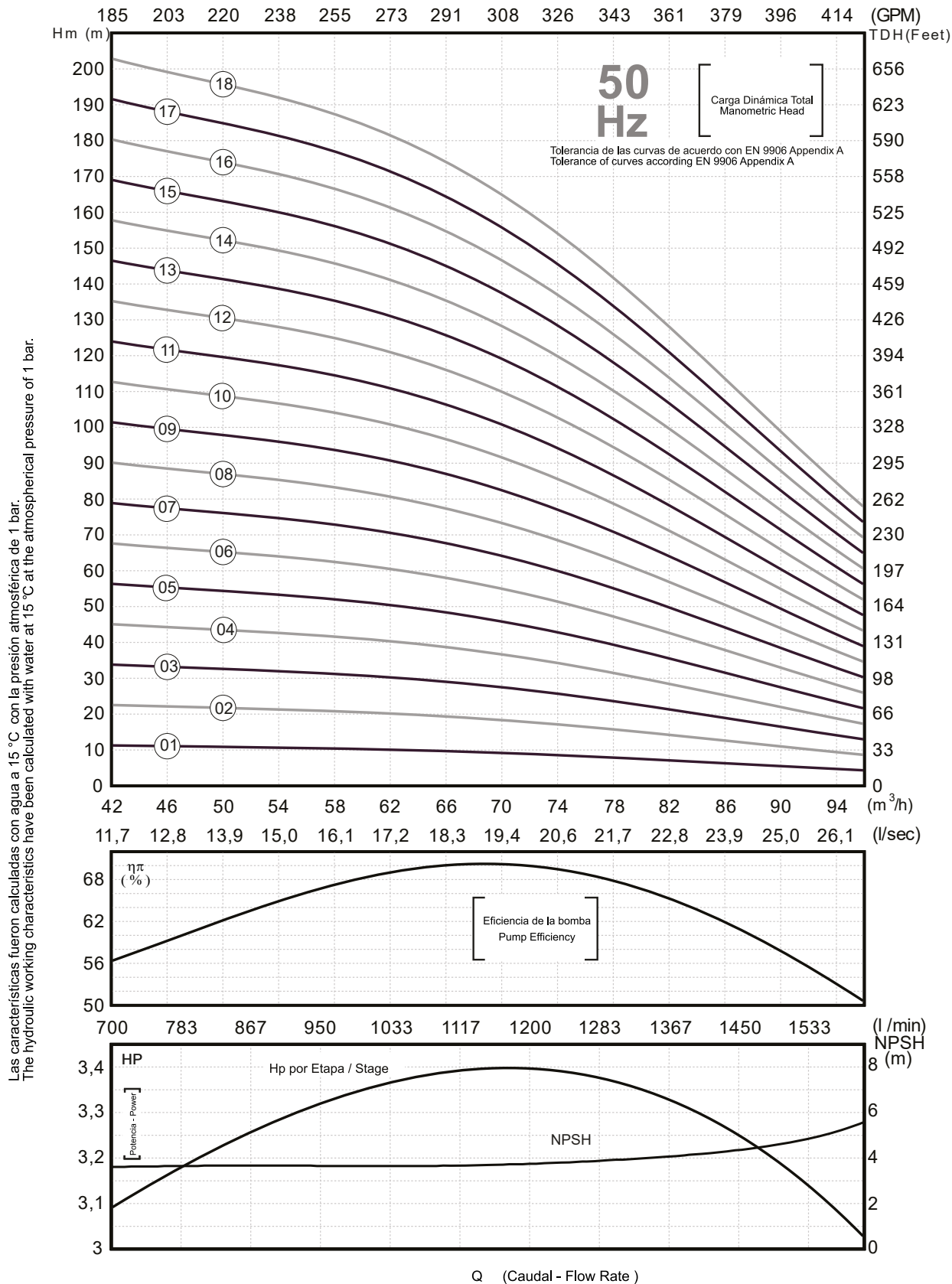

Desempeño de las curvas están basadas en la viscosidad $\nu = 1\text{mm}^2/\text{s}$ y densidad $\rho = 1000\text{ kg/m}^3$
Performance curves are based on the kinematic viscosity $\nu = 1\text{mm}^2/\text{s}$ and density $\rho = 1000\text{ kg/m}^3$

SS 690



**BOMBAS DE ACERO
INOXIDABLE**
50 Hz

Especificaciones

- Rango de operación en 50hz: Q = 75 m³/h - 120 m³/h
 - Descarga: 4" con hilo en descarga 11 TPI
 - Tipo del impulsor: flujo mixto
 - Sentido de rotación: anti horaria
 - Conexión: según estándar NEMA
 - Diámetro del eje: 22mm
 - Diámetro máximo de la bomba: 149mm (incluyendo guarda cable)
- Estándares de seguridad y fabricación:
 - TS 11146:2014
 - EN 809:1998+A1+2009+AC:2010

2006/42/EC
EN ISO 12100:2010

- Líquido a bombear: agua limpia
- Paso máximo de sólidos: 2 mm
- Concentración máxima de sólidos: 50 PPM
- Nivel mínimo de líquido (NPSH): 800mm desde el fondo de la ranura de succión

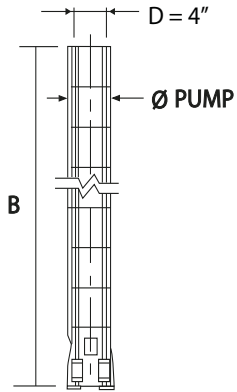

MODELO	MOTOR				ETAPAS	DIMENSIONES (mm)						PESO (kg)		
	4" HP	6" HP	8" HP	kW		4"	6"	8"	Ø BOMBA	Ø D	BOMBA			
						B	B	B			6"-4"	6"-6"	6"-8"	
SS 690/01	5,5	5,5	-	4	1	439	439	-	149	4"	11	11	-	
SS 690/02	10	10	-	7,5	2	580	580	-	149	4"	14	14	-	
SS 690/03	-	15	-	11	3	-	721	-	149	4"	-	17	-	
SS 690/04	-	20	-	15	4	-	862	-	149	4"	-	20	-	
SS 690/05	-	25	-	18,5	5	-	1003	-	149	4"	-	23	-	
SS 690/06	-	30	-	22	6	-	1144	1173	149	4"	-	26	-	
SS 690/07	-	40	40	30	7	-	1285	1314	149	4"	-	29	32	
SS 690/08	-	40	40	30	8	-	1426	1455	149	4"	-	32	35	
SS 690/09	-	50	50	37	9	-	1567	1596	149	4"	-	35	38	
SS 690/10	-	50	50	37	10	-	1708	1737	149	4"	-	38	41	
SS 690/11	-	60	60	45	11	-	1849	1878	149	4"	-	41	44	
SS 690/12	-	60	60	45	12	-	1990	2019	149	4"	-	44	47	

MODELO	MOTOR				m³/h	0	75	84	90	96	100	105	110	115	120
	4" HP	6" HP	8" HP	kW		l / seg	20,83	23,33	25,00	26,67	27,78	29,17	30,56	31,94	33,33
						gpm	0	330	370	396	423	440	462	484	506
SS 690/01	5,5	5,5	-	4	CARGA DINÁMICA TOTAL (m)	15	11	11	10	9	9	8	8	7	6
SS 690/02	10	10	-	7,5		31	22	21	20	19	18	17	16	14	13
SS 690/03	-	15	-	11		46	33	32	30	28	27	25	23	21	19
SS 690/04	-	20	-	15		62	44	42	40	38	36	33	31	28	25
SS 690/05	-	25	-	18,5		77	55	53	50	47	45	42	39	35	31
SS 690/06	-	30	-	22		93	66	63	60	57	54	50	47	42	38
SS 690/07	-	40	40	30		108	77	74	70	66	63	59	55	50	44
SS 690/08	-	40	40	30		124	88	84	80	76	72	67	62	57	50
SS 690/09	-	50	50	37		139	98	95	90	85	81	75	70	64	56
SS 690/10	-	50	50	37		155	109	105	100	95	90	84	78	71	63
SS 690/11	-	60	60	45		170	120	116	110	104	99	92	86	78	69
SS 690/12	-	60	60	45		186	131	126	120	113	108	100	94	85	75

Fecha 03/2016 | Rev 01

Franklin Electric reserva el derecho a modificar productos sin previo aviso.

SS 690



**BOMBAS DE ACERO
INOXIDABLE**
50 Hz

Curvas de Rendimiento - 01 a 12 etapas

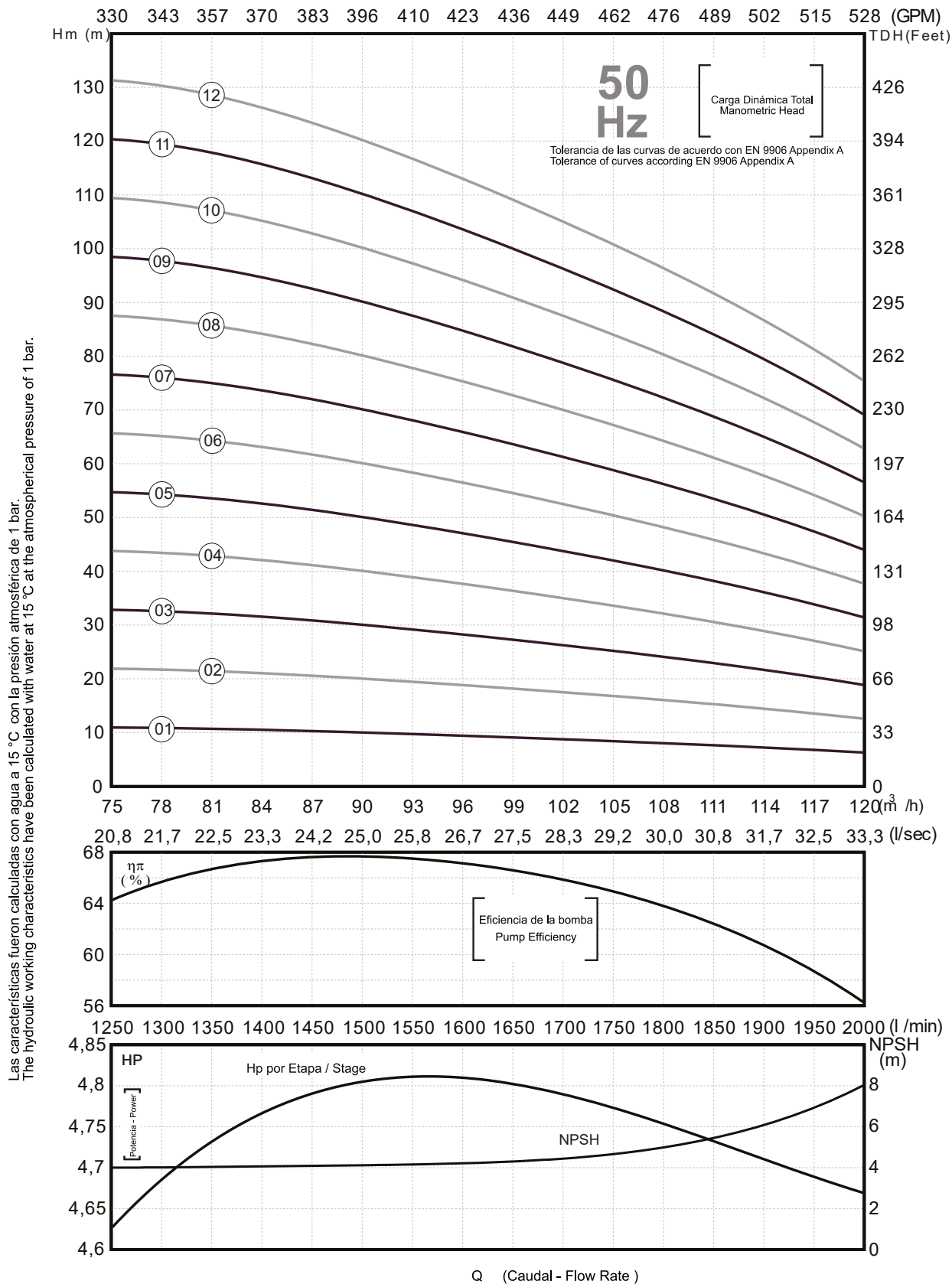

Desempeño de las curvas están basadas en la viscosidad $\nu = 1\text{mm}^2/\text{s}$ y densidad $\rho = 1000\text{ kg/m}^3$
Performance curves are based on the kinematic viscosity $\nu = 1\text{mm}^2/\text{s}$ and density $\rho = 1000\text{ kg/m}^3$

SS 609



**BOMBAS DE ACERO
INOXIDABLE**
50 Hz

Componentes y Montaje

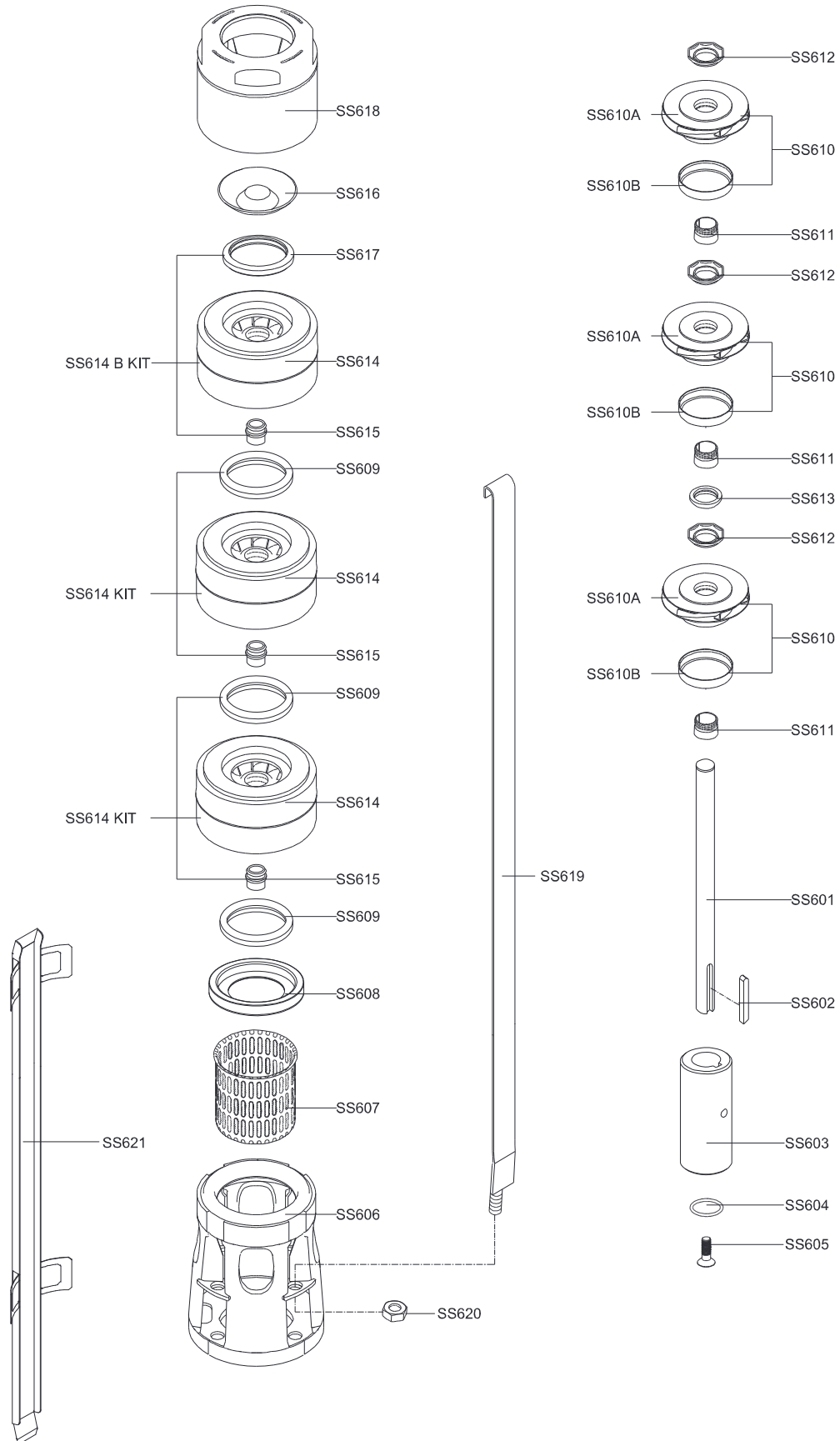

Lista de Componentes

Parte	Descripción	Material	Tipo
SS601	Eje	Acero Inoxidable	AISI 420
SS602	Chaveta	Acero Inoxidable	AISI 304
SS603	Acoplamiento	Acero Inoxidable	AISI 420
SS604	O-ring	Nitrilo	-
SS605	Tornillo de acoplamiento	Acero Inoxidable	AISI 304
SS606	Soporte	Acero Inoxidable	AISI 304
SS607	Filtro	Acero Inoxidable	AISI 304
SS608	Retenedor de Anillos del Cuello	Acero Inoxidable	AISI 420
SS609	Anillo de Cuello	Nitrilo / Acero clase 42	-
SS610A	Impulsor	Acero Inoxidable	AISI 304
SS610B	Anillo de Impulsor	Acero Inoxidable	AISI 304
SS611	Cono de Separación	Acero Inoxidable	AISI 420
SS612	Tuerca de Cono de Separación	Acero Inoxidable	AISI 304
SS613	Arandela espaciadora para Anillo de Retención	Composito Termoplástico	-
SS614	Difusor	Acero Inoxidable	AISI 304
SS 614 KIT	Difusor	Acero Inoxidable	AISI 304
	Buje	Nitrilo	-
	Anillo de Cuello	Nitrilo / Acero clase 42	-
SS 614 B KIT	Difusor	Acero Inoxidable	AISI 304
	Buje	Nitrilo	-
	Asiento de Válvula	Nitrilo / Acero clase 42	-
SS615	Buje	Nitrilo	-
SS616	Válvula del Cono	Acero Inoxidable	AISI 304
SS617	Asiento de Válvula	Nitrilo / Acero clase 42	-
SS618	Descarga (2 1/2" Normal)	Acero Inoxidable	AISI 304
SS619	Tirante	Acero Inoxidable	AISI 304
SS620	Tuerca del Tirante	Acero Inoxidable	AISI 304
SS621	Guardacable	Acero Inoxidable	AISI 304

SS 612



**BOMBAS DE ACERO
INOXIDABLE**
50 Hz

Componentes y Montaje

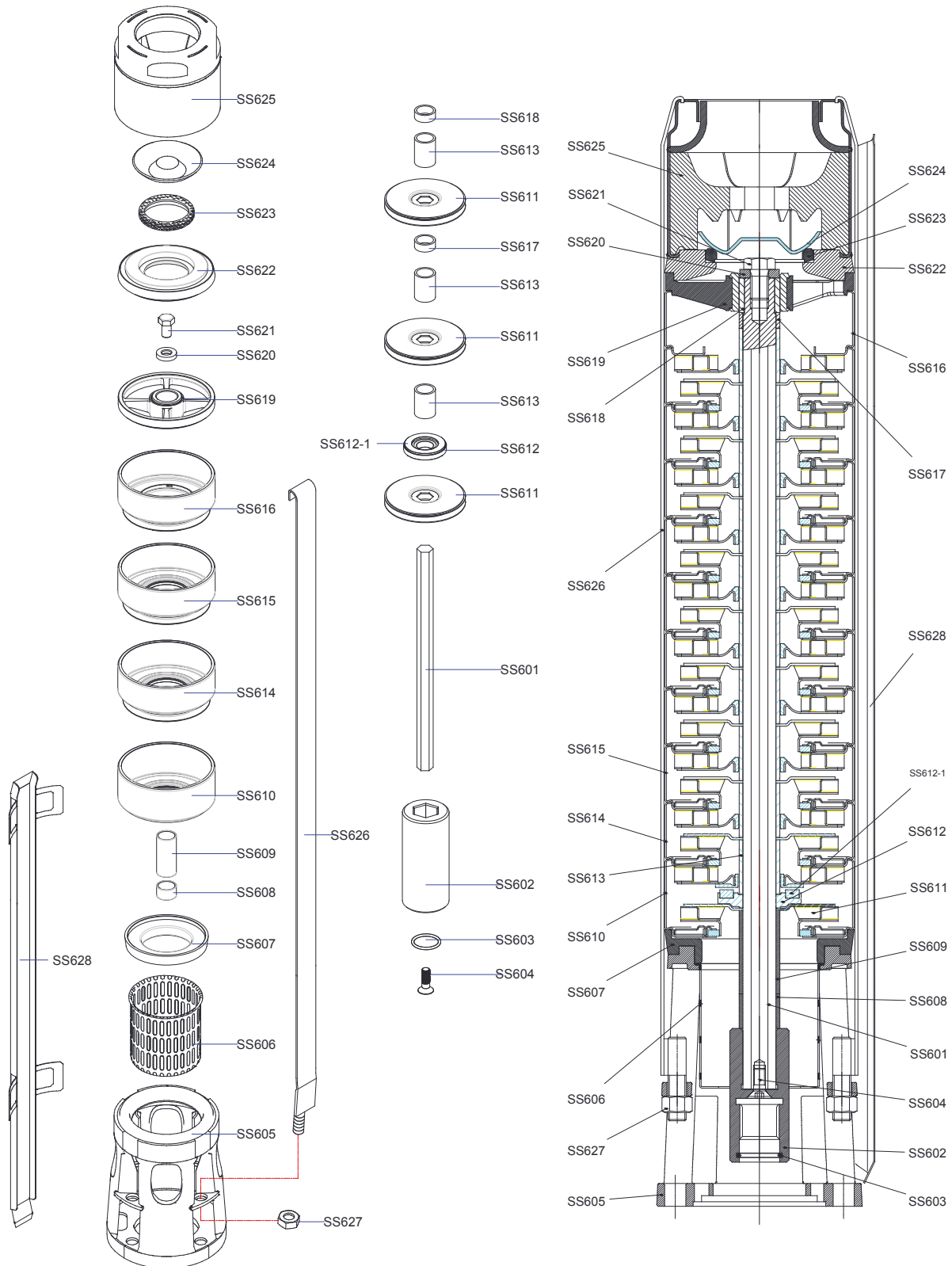

Lista de Componentes

Parte	Descripción	Material	Tipo
SS601	Eje	Acero Inoxidable	AISI 304
SS602	Acoplamiento	Acero Inoxidable	AISI 420
SS603	O-ring	Nitrilo	-
SS604	Tornillo del acoplamiento	Acero Inoxidable	AISI 304
SS605	Soporte	Acero Inoxidable	AISI 304
SS606	Filtro	Acero Inoxidable	AISI 304
SS607	Brida del Soporte	Acero Inoxidable	AISI 420
SS608	Espaciador inferior - bajo	Acero Inoxidable	AISI 304
SS609	Espaciador inferior - largo	Acero Inoxidable	AISI 304
SS610	Premero difusor	Acero Inoxidable	AISI 304
SS611	Impulsor	Acero Inoxidable	AISI 304
SS612	Arandela inferior	Acero Inoxidable	AISI 316
SS612-1	Anillo inferior	Composito Termoplástico	-
SS613	Espaciador del Impulsor	Acero Inoxidable	AISI 304
SS614	Difusor con arandela superior	Acero Inoxidable	AISI 304
SS615	Difusor	Acero Inoxidable	AISI 304
SS616	Último difusor	Acero Inoxidable	AISI 304
SS617	Espaciador superior	Acero Inoxidable	AISI 304
SS618	Manga buje superior	Acero Inoxidable	AISI 304
SS619	Guía del buje superior	Acero Inoxidable	AISI 304
SS620	Arandela	Acero Inoxidable	AISI 304
SS621	Tornillo	Acero Inoxidable	AISI 304
SS622	Anillo del asiento	Acero Inoxidable	AISI 304
SS623	Asiento de válvula	Nitrilo / Acero clase 42	-
SS624	Válvula del Cono	Acero Inoxidable	AISI 304
SS625	Descarga (2 1/2" Normal)	Acero Inoxidable	AISI 304
SS626	Tirante	Acero Inoxidable	AISI 304
SS627	Tuerca del Tirante	Acero Inoxidable	AISI 304
SS628	Guardacable	Acero Inoxidable	AISI 304

SS 615



**BOMBAS DE ACERO
INOXIDABLE**
50 Hz

Componentes y Montaje

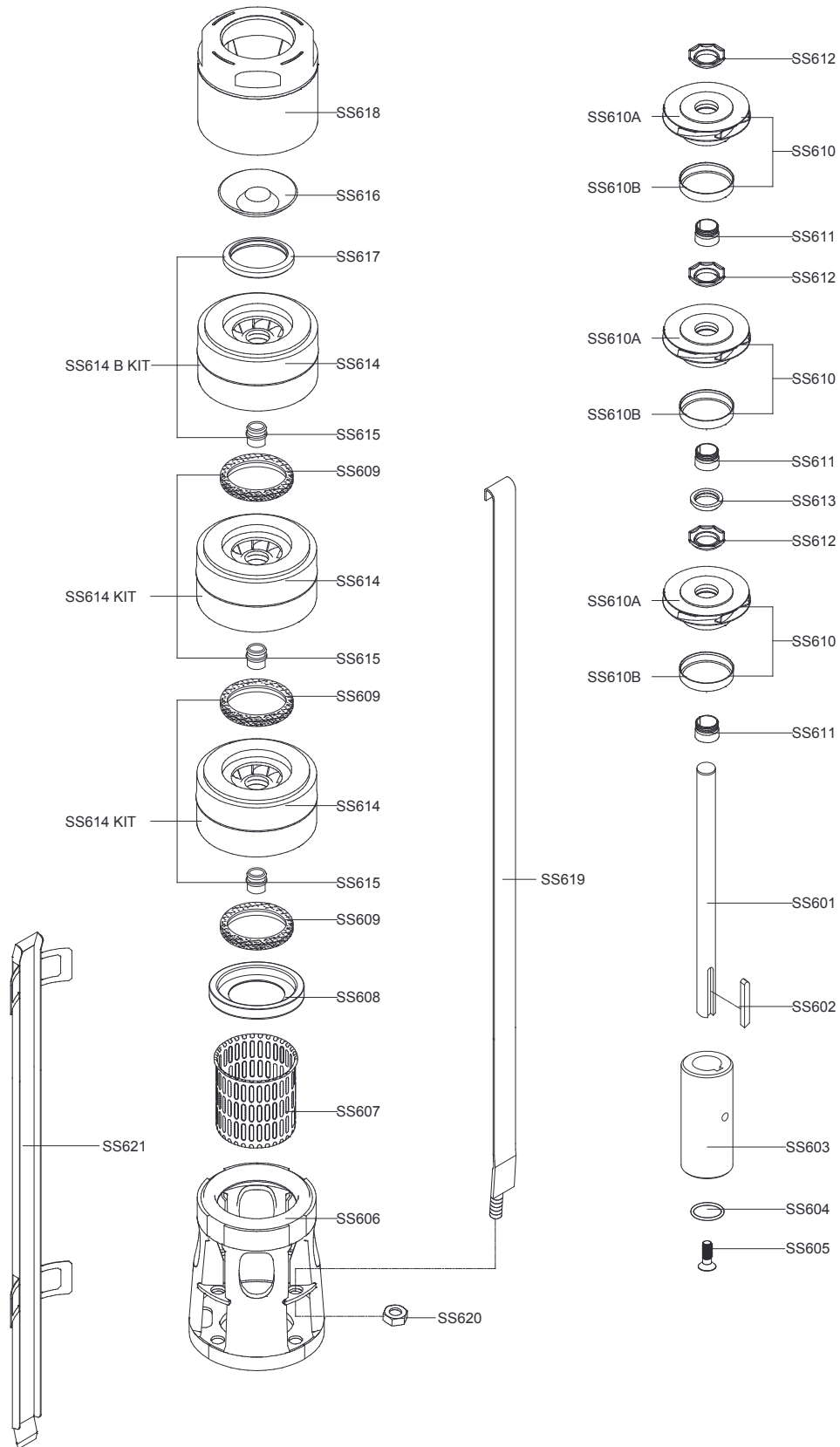

SS 615



**BOMBAS DE ACERO
INOXIDABLE**
50 Hz

Lista de Componentes

Parte	Descripción	Material	Tipo
SS601	Eje	Acero Inoxidable	AISI 420
SS602	Chaveta	Acero Inoxidable	AISI 304
SS603	Acoplamiento	Acero Inoxidable	AISI 420
SS604	O-ring	Nitrilo	-
SS605	Tornillo de acoplamiento	Acero Inoxidable	AISI 304
SS606	Soporte	Acero Inoxidable	AISI 304
SS607	Filtro	Acero Inoxidable	AISI 304
SS608	Retenedor de Anillos del Cuello	Acero Inoxidable	AISI 420
SS609	Anillo de Cuello	Nitrilo / Acero clase 42	-
SS610A	Impulsor	Acero Inoxidable	AISI 304
SS610B	Anillo de Impulsor	Acero Inoxidable	AISI 304
SS611	Cono de Separación	Acero Inoxidable	AISI 420
SS612	Tuerca de Cono de Separación	Acero Inoxidable	AISI 304
SS613	Arandela espaciadora para Anillo de Retención	Composito Termoplástico	-
SS614	Difusor	Acero Inoxidable	AISI 304
SS 614 KIT	Difusor	Acero Inoxidable	AISI 304
	Buje	Nitrilo	-
	Anillo de Cuello	Nitrilo / Acero clase 42	-
SS 614 B KIT	Difusor	Acero Inoxidable	AISI 304
	Buje	Nitrilo	-
	Asiento de Válvula	Nitrilo / Acero clase 42	-
SS615	Buje	Nitrilo	-
SS616	Válvula del Cono	Acero Inoxidable	AISI 304
SS617	Asiento de Válvula	Nitrilo / Acero clase 42	-
SS618	Descarga (2 1/2" Normal)	Acero Inoxidable	AISI 304
SS619	Tirante	Acero Inoxidable	AISI 304
SS620	Tuerca del Tirante	Acero Inoxidable	AISI 304
SS621	Guardacable	Acero Inoxidable	AISI 304

SS 624 | SS 630



**BOMBAS DE ACERO
INOXIDABLE**
50 Hz

Componentes y Montaje

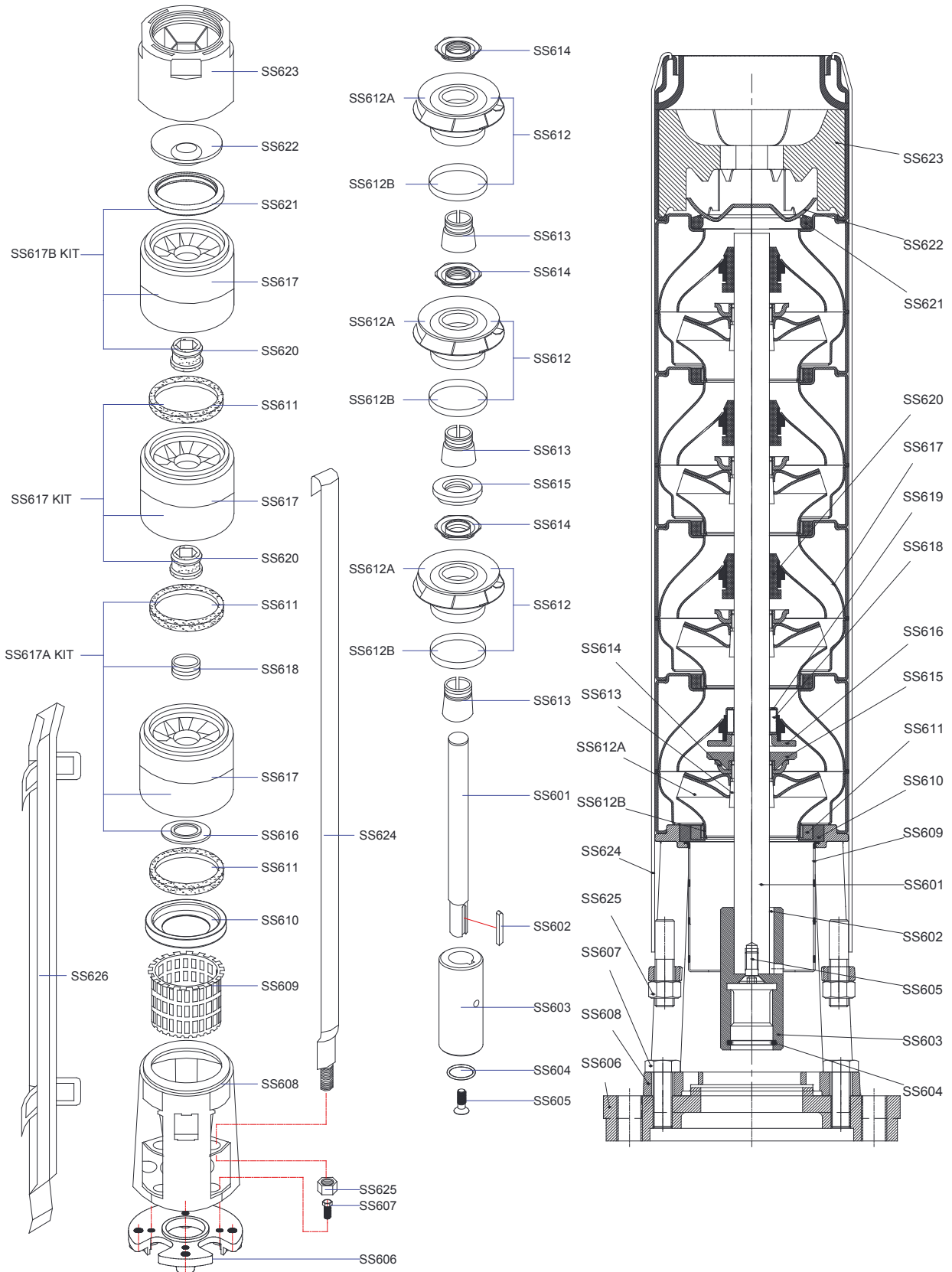

Lista de Componentes

Parte	Descripción	Material	Tipo
SS601	Eje	Acero Inoxidable	AISI 420
SS602	Chaveta	Acero Inoxidable	AISI 304
SS603	Acoplamiento	Acero Inoxidable	AISI 420
SS604	O-ring	Nitrilo	-
SS605	Tornillo del acoplamiento	Acero Inoxidable	AISI 304
SS606	Brida	Acero Inoxidable	AISI 420
SS607	Tornillo de la Brida	Acero Inoxidable	AISI 304
SS608	Soporte	Acero Inoxidable	AISI 304
SS609	Filtro	Acero Inoxidable	AISI 304
SS610	Retenedor de Anillos de Cuello	Acero Inoxidable	AISI 304
SS611	Anillo de Cuello	Nitrilo / Acero clase 42	-
SS612A	Impulsor	Acero Inoxidable	AISI 304
SS612B	Anillo del Impulsor	Acero Inoxidable	AISI 304
SS613	Cono de Separación	Acero Inoxidable	AISI 304
SS614	Tuerca de Cono de Separación	Acero Inoxidable	AISI 304
SS615	Arandela espaciadora para Anillo de Retención	Composito Termoplástico	-
SS616	Anillo de Retención	Acero Inoxidable	AISI 304
SS617	Difusor	Acero Inoxidable	AISI 304
SS617 A KIT	Difusor	Acero Inoxidable	AISI 304
	Buje	Nitrilo / Acero clase 42	-
	Casquillo del Buje del Difusor	Nitrilo / Acero clase 42	-
	Anillo de Cuello	Nitrilo / Acero clase 42	-
SS617 KIT	Difusor	Acero Inoxidable	AISI 304
	Buje	Nitrilo / Acero clase 42	-
	Anillo de Cuello	Nitrilo / Acero clase 42	-
SS617 B KIT	Difusor	Acero Inoxidable	AISI 304
	Buje	Nitrilo / Acero clase 42	-
	Asiento de Válvula	Nitrilo / Acero clase 42	-
SS618	Buje	Nitrilo / Acero clase 42	-
SS620	Buje	Nitrilo	-
SS621	Asiento de Válvula	Nitrilo / Acero clase 42	-
SS622	Válvula del Cono	Acero Inoxidable	AISI 304
SS623	Descarga (2 1/2" Normal)	Acero Inoxidable	AISI 304
SS624	Tirante	Acero Inoxidable	AISI 304
SS625	Tuerca del Tirante	Acero Inoxidable	AISI 304
SS626	Guardacable	Acero Inoxidable	AISI 304

Componentes y Montaje

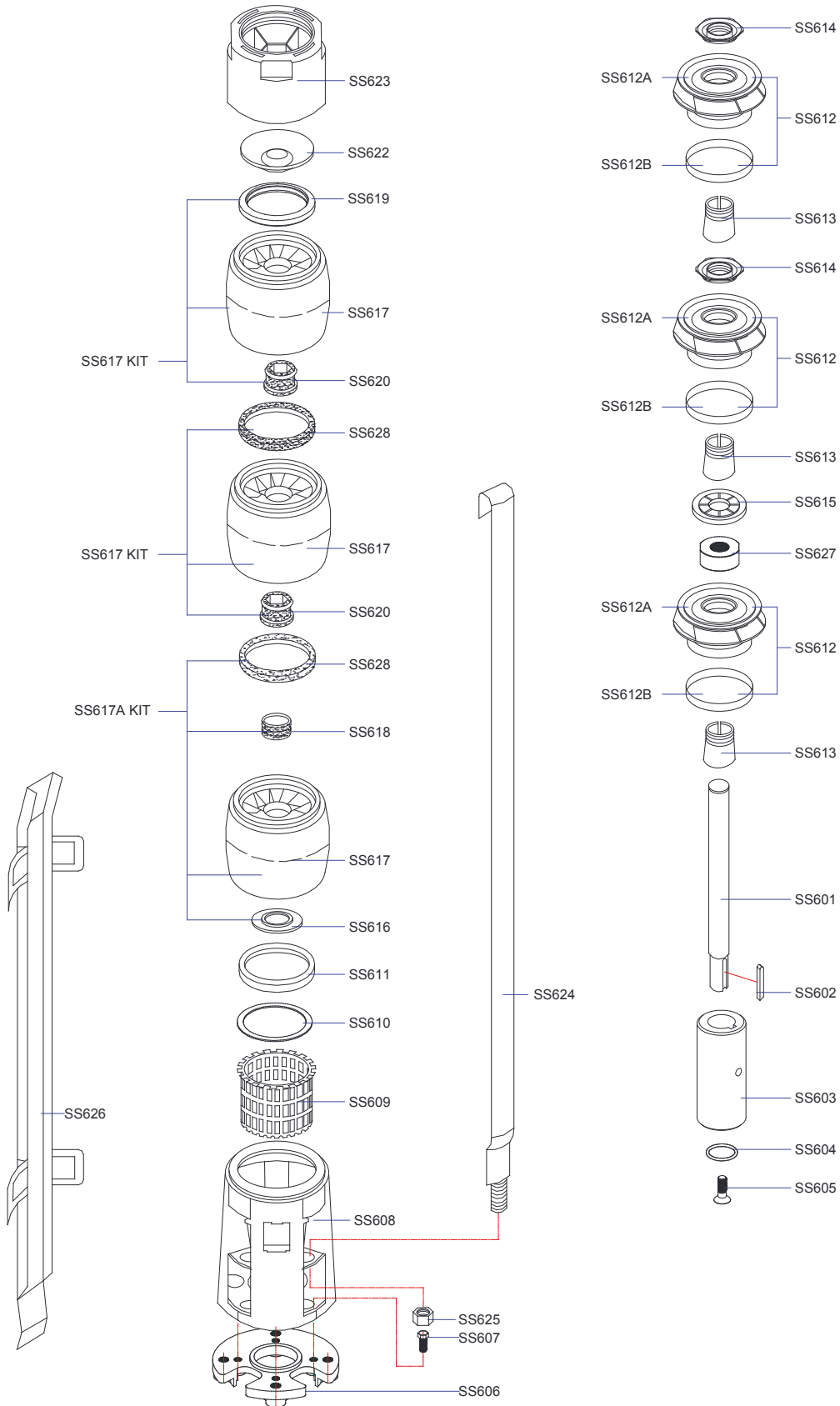

Lista de Componentes

Parte	Descripción	Material	Tipo
SS601	Eje	Acero Inoxidable	AISI 420
SS602	Chaveta	Acero Inoxidable	AISI 304
SS603	Acoplamiento	Acero Inoxidable	AISI 420
SS604	O-ring	Nitrilo	-
SS605	Tornillo del acoplamiento	Acero Inoxidable	AISI 304
SS606	Brida	Acero Inoxidable	AISI 420
SS607	Tornillo de la Brida	Acero Inoxidable	AISI 304
SS608	Soporte	Acero Inoxidable	AISI 304
SS609	Filtro	Acero Inoxidable	AISI 304
SS610	Retenedor de Anillos de Cuello	Acero Inoxidable	AISI 304
SS611	Anillo de Cuello	Nitrilo / Acero clase 42	-
SS612A	Impulsor	Acero Inoxidable	AISI 304
SS612B	Anillo del Impulsor	Acero Inoxidable	AISI 304
SS613	Cono de Separación	Acero Inoxidable	AISI 304
SS614	Tuerca de Cono de Separación	Acero Inoxidable	AISI 304
SS615	Arandela espaciadora para Anillo de Retención	Composito Termoplástico	-
SS616	Anillo de Retención	Acero Inoxidable	AISI 304
SS617	Difusor	Acero Inoxidable	AISI 304
SS617 A KIT	Difusor	Acero Inoxidable	AISI 304
	Buje	Nitrilo / Acero clase 42	-
	Casquillo del Buje del Difusor	Nitrilo / Acero clase 42	-
	Anillo de Cuello	Nitrilo / Acero clase 42	-
SS617 KIT	Difusor	Acero Inoxidable	AISI 304
	Buje	Nitrilo / Acero clase 42	-
	Anillo de Cuello	Nitrilo / Acero clase 42	-
SS617 B KIT	Difusor	Acero Inoxidable	AISI 304
	Buje	Nitrilo / Acero clase 42	-
	Asiento de Válvula	Nitrilo / Acero clase 42	-
SS618	Buje	Nitrilo / Acero clase 42	-
SS619	Asiento de Válvula	Nitrilo / Acero clase 42	-
SS620	Buje	Nitrilo	-
SS622	Válvula del Cono	Acero Inoxidable	AISI 304
SS623 A	Descarga (3" Normal)	Acero Inoxidable	AISI 304
SS623 B	Descarga (4" Normal)	Acero Inoxidable	AISI 304
SS624	Tirante	Acero Inoxidable	AISI 304
SS625	Tuerca del Tirante	Acero Inoxidable	AISI 304
SS626	Guardacable	Acero Inoxidable	AISI 304
SS627	Tuerca	Acero Inoxidable	AISI 420
SS628	Anillo de Cuello	Nitrilo / Acero clase 42	-

SS 675 | SS 690



**BOMBAS DE ACERO
INOXIDABLE**
50 Hz

Componentes y Montaje

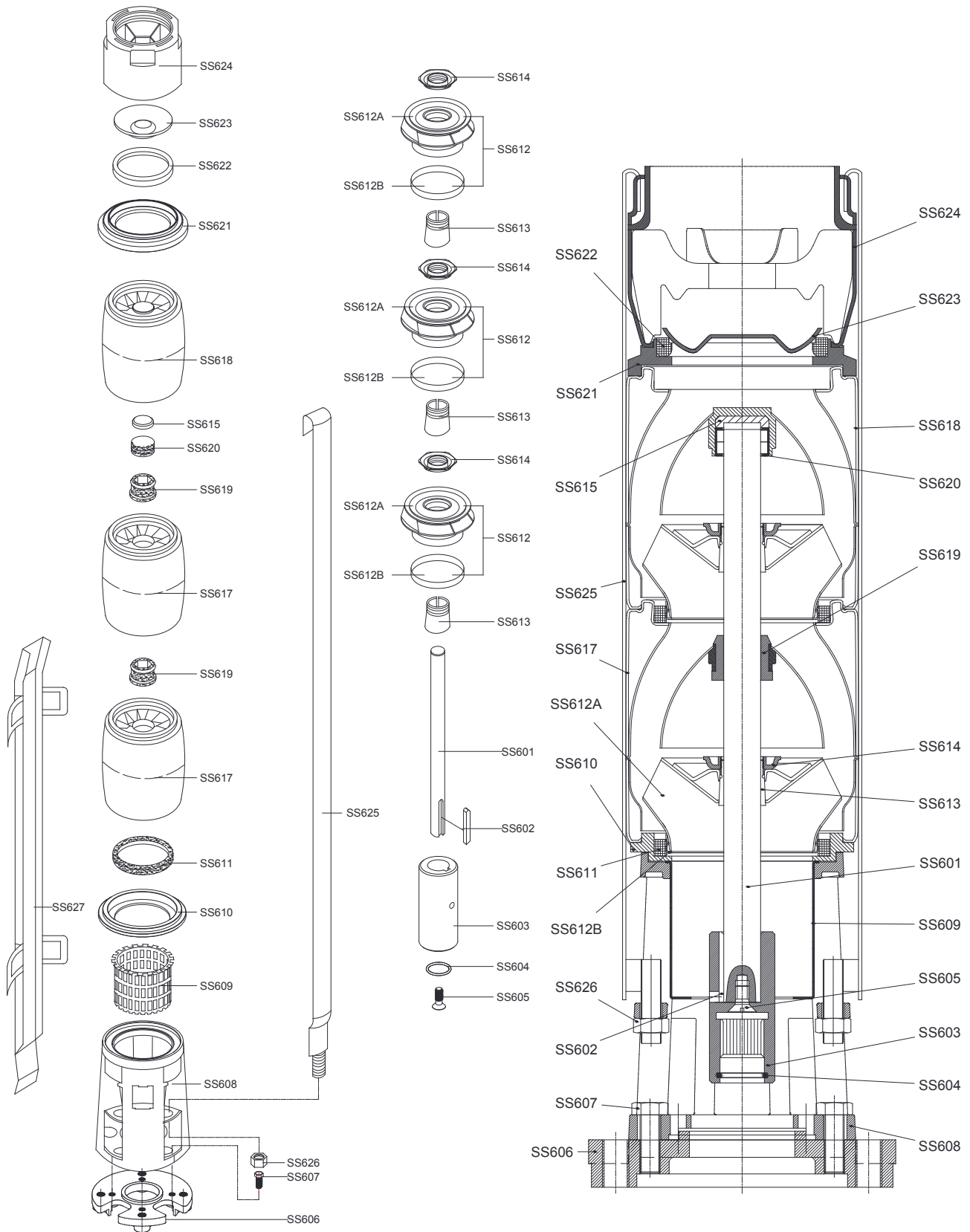

SS 675 | SS 690



**BOMBAS DE ACERO
INOXIDABLE**
50 Hz

Lista de Componentes

Parte	Descripción	Material	Tipo
SS601	Eje	Acero Inoxidable	AISI 420
SS602	Chaveta	Acero Inoxidable	AISI 304
SS603	Acoplamiento	Acero Inoxidable	AISI 420
SS604	O-ring	Nitrilo	-
SS605	Tornillo del acoplamiento	Acero Inoxidable	AISI 304
SS606	Brida	Acero Inoxidable	AISI 420
SS607	Tornillo de la Brida	Acero Inoxidable	AISI 304
SS608	Soporte	Acero Inoxidable	AISI 304
SS609	Filtro	Acero Inoxidable	AISI 304
SS610	Retenedor de Anillos de Cuello	Acero Inoxidable	AISI 304
SS611	Anillo de Cuello	Nitrilo / Acero clase 42	-
SS612A	Impulsor	Acero Inoxidable	AISI 304
SS612B	Anillo del Impulsor	Acero Inoxidable	AISI 304
SS613	Cono de Separación	Acero Inoxidable	AISI 420
SS614	Tuerca de Cono de Separación	Acero Inoxidable	AISI 304
SS615	Arandela espaciadora para Anillo de Retención	Composito Termoplástico	-
SS617	Difusor	Acero Inoxidable	AISI 304
SS618	Difusor com retención	Acero Inoxidable	AISI 304
SS619	Buje	Nitrilo	-
SS620	Buje	Nitrilo / Acero clase 42	-
SS621	Anillo de Válvula	Acero Inoxidable	AISI 304
SS622	Asiento de Válvula	Nitrilo / Acero clase 42	-
SS623	Válvula del Cono	Acero Inoxidable	AISI 304
SS624	Descarga (4" Normal)	Acero Inoxidable	AISI 304
SS625	Tirante	Acero Inoxidable	AISI 304
SS626	Tuerca del Tirante	Acero Inoxidable	AISI 304
SS627	Guardacable	Acero Inoxidable	AISI 304



agricultura
industria
servicios sanitario
minería



agriculture
industry
water authority
mining

FPS

8



FPS
serie SS

SS 872



**BOMBAS DE ACERO
INOXIDABLE**
50 Hz

Especificaciones

- Rango de operación en 50hz: Q = 60 m³/h - 104 m³/h
 - Descarga: 5" con hilo en descarga 11 TPI
 - Tipo del impulsor: flujo mixto
 - Sentido de rotación: anti horaria
 - Conexión: según estándar NEMA
 - Diámetro del eje: 25mm
 - Diámetro máximo de la bomba: 182mm (incluyendo guarda cable)
 - Líquido a bombear: agua limpia
 - Paso máximo de sólidos: 2 mm
 - Concentración máxima de sólidos: 50 PPM
 - Nivel mínimo de líquido (NPSH): 1200mm desde el fondo de la ranura de succión
- Estándares de seguridad y fabricación:
- TS 11146:2014
 - EN 809:1998+A1+2009+AC:2010
 - 2006/42/EC
 - EN ISO 12100:2010

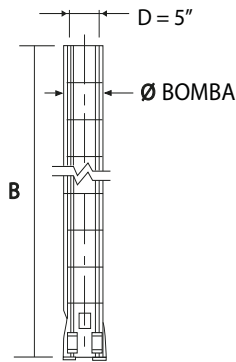

MODELO	MOTOR			ETAPAS	DIMENSIONES (mm)					PESO (kg)	
	6" HP	8" HP	kW		8"-6"	8"-8"	8"-6"	8"-8"	Ø D	BOMBA	
					B	B	Ø BOMBA	Ø BOMBA		8"-6"	8"-8"
SS 872/01	5,5	-	4	1	570	-	174	-	5"	22	-
SS 872/02	10	-	7,5	2	698	-	174	-	5"	25	-
SS 872/03	15	-	11	3	826	-	174	-	5"	29	-
SS 872/04	20	-	15	4	954	-	174	-	5"	32	-
SS 872/05	25	-	18,5	5	1082	-	174	-	5"	35	-
SS 872/06	30	-	22	6	1210	1221	174	182	5"	39	-
SS 872/07	40	40	30	7	1338	1349	174	182	5"	42	44
SS 872/08	40	40	30	8	1466	1477	174	182	5"	45	48
SS 872/09	40	40	30	9	1594	1605	174	182	5"	49	52
SS 872/10	50	50	37	10	1722	1733	174	182	5"	52	55
SS 872/11	50	50	37	11	1850	1861	174	182	5"	56	59
SS 872/12	60	60	45	12	1978	1989	174	182	5"	59	63
SS 872/13	60	60	45	13	2106	2117	174	182	5"	62	67
SS 872/14	-	70	52	14	-	2245	-	182	5"	-	71
SS 872/15	-	70	52	15	-	2373	-	182	5"	-	75
SS 872/16	-	75	55	16	-	2501	-	182	5"	-	79
SS 872/17	-	75	55	17	-	2629	-	182	5"	-	83
SS 872/18	-	80	59	18	-	2757	-	182	5"	-	87
SS 872/19	-	90	66	19	-	2885	-	182	5"	-	91
SS 872/20	-	90	66	20	-	3013	-	182	5"	-	95
SS 872/21	-	100	75	21	-	3141	-	182	5"	-	98
SS 872/22	-	100	75	22	-	3269	-	182	5"	-	102

MODELO	MOTOR			m ³ /h	CARGA DINÁMICA TOTAL (m)															
	6" HP	8" HP	kW		0	60	64	68	72	76	80	84	88	92	96	100	104			
					l / seg	0,00	16,67	17,78	18,89	20,00	21,11	22,22	23,33	24,44	25,56	26,67	27,78	28,89		
				gpm	0	264	282	299	317	335	352	370	387	405	423	440	458			
SS 872/01	5,5	-	4		19	14	13	13	13	12	12	11	11	10	9	9	8			
SS 872/02	10	-	7,5		36	27	26	26	25	24	23	22	21	20	19	18	16			
SS 872/03	15	-	11		55	41	40	39	38	37	35	34	32	30	28	27	24			
SS 872/04	20	-	15		72	55	54	52	51	49	46	45	42	40	38	36	32			
SS 872/05	25	-	18,5		92	69	67	65	64	61	58	56	53	50	47	45	40			
SS 872/06	30	-	22		110	82	80	78	76	73	70	67	64	60	56	54	48			
SS 872/07	40	40	30		129	96	94	91	89	85	81	78	74	70	66	63	56			
SS 872/08	40	40	30		148	110	107	104	102	98	93	90	85	80	75	72	64			
SS 872/09	40	40	30		165	123	121	117	114	110	104	101	95	90	85	81	72			
SS 872/10	50	50	37		184	137	134	130	127	122	116	112	106	100	94	90	80			
SS 872/11	50	50	37		203	151	147	143	140	134	128	123	117	110	103	99	88			
SS 872/12	60	60	45		220	164	161	156	152	146	139	134	127	120	113	108	96			
SS 872/13	60	60	45		233	178	174	169	165	159	151	146	138	130	122	117	104			
SS 872/14	-	70	52		247	192	188	182	178	171	162	157	148	140	132	126	112			
SS 872/15	-	70	52		265	206	201	195	191	183	174	168	159	150	141	135	120			
SS 872/16	-	75	55		294	219	214	208	203	195	186	179	170	160	150	144	128			
SS 872/17	-	75	55		313	233	228	221	216	207	197	190	180	170	160	153	136			
SS 872/18	-	80	59		332	247	241	234	229	220	209	202	191	180	169	162	144			
SS 872/19	-	90	66		349	260	255	247	241	232	220	213	201	190	179	171	152			
SS 872/20	-	90	66		368	274	268	260	254	244	232	224	212	200	188	180	160			
SS 872/21	-	100	75		387	288	281	273	267	256	244	235	223	210	197	189	168			
SS 872/22	-	100	75		406	301	295	286	279	268	255	246	233	220	207	198	176			

Fecha 03/2016 | Rev 01

Franklin Electric reserva el derecho a modificar productos sin previo aviso.

SS 872



**BOMBAS DE ACERO
INOXIDABLE**
50 Hz

Curvas de Rendimiento - 01 a 22 etapas

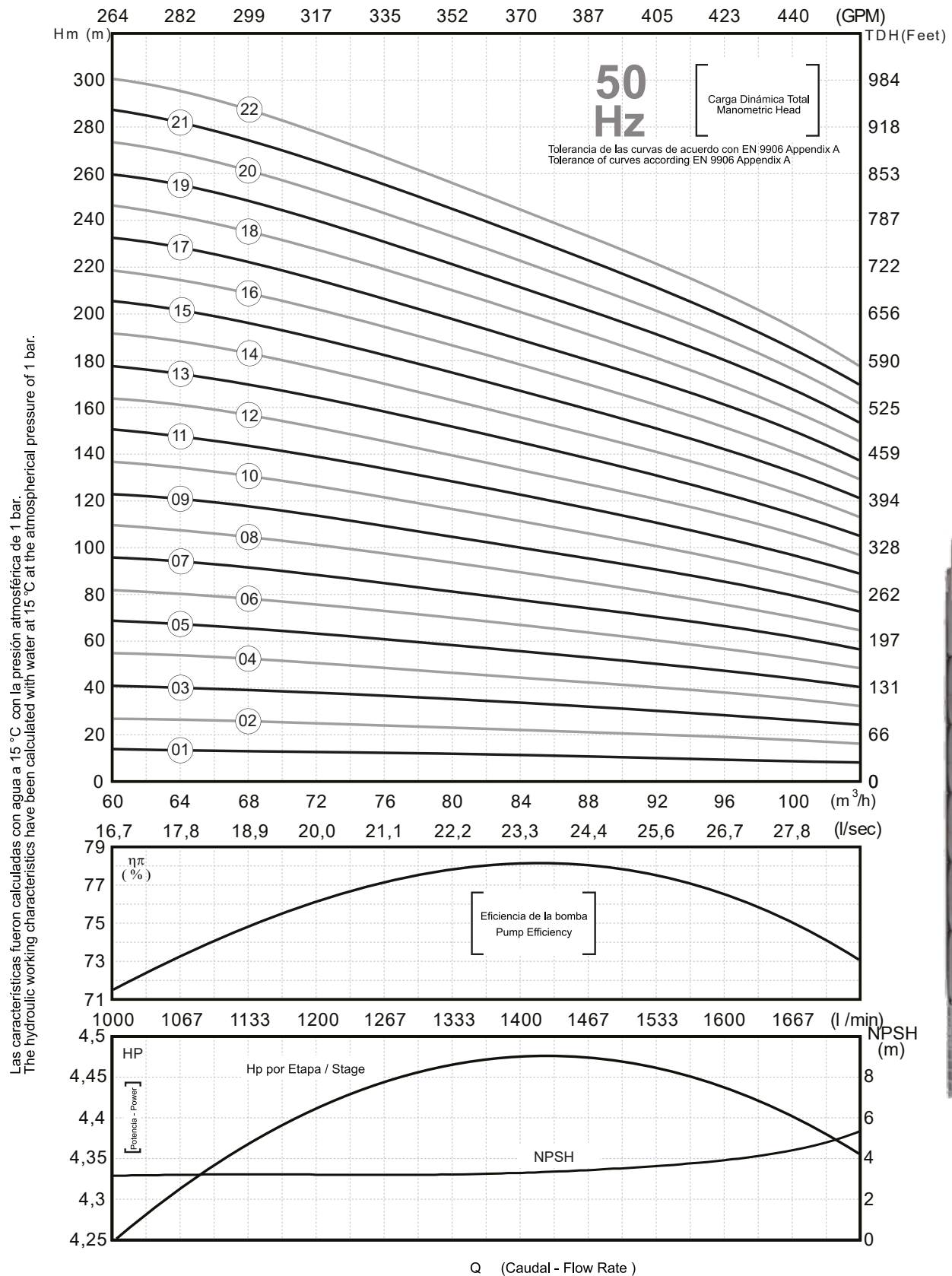

Desempeño de las curvas están basadas en la viscosidad $\nu = 1\text{mm}^2/\text{s}$ y densidad $\rho = 1000\text{ kg/m}^3$
Performance curves are based on the kinematic viscosity $\nu = 1\text{mm}^2/\text{s}$ and density $\rho = 1000\text{ kg/m}^3$

SS 896



**BOMBAS DE ACERO
INOXIDABLE**
50 Hz

Especificaciones

- Rango de operación en 50hz: Q = 68 m³/h - 112 m³/h
 - Descarga: 5" con hilo en descarga 11 TPI
 - Tipo del impulsor: flujo mixto
 - Sentido de rotación: anti horaria
 - Conexión: según estándar NEMA
 - Diámetro del eje: 25mm
 - Diámetro máximo de la bomba: 182mm (incluyendo guarda cable)
 - Líquido a bombear: agua limpia
 - Paso máximo de sólidos: 2 mm
 - Concentración máxima de sólidos: 50 PPM
 - Nivel mínimo de líquido (NPSH): 1200mm desde el fondo de la ranura de succión
- Estándares de seguridad y fabricación:
- TS 11146:1193 TS EN 809:2000 98/37/EC
 - TS EN ISO 12100-1:2007 TS EN ISO 12100-2:2006

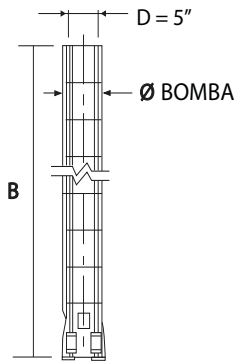

MODELO	MOTOR			ETAPAS	DIMENSIONES (mm)					PESO (kg)	
					8"-6"	8"-8"	8"-6"	8"-8"	Ø D	BOMBA	
	6" HP	8" HP	kW		B	B	Ø BOMBA	Ø BOMBA		8"-6"	8"-8"
SS 896/01	5,5	-	4	1	570	-	174	-	5"	22	-
SS 896/02	10	-	7,5	2	698	-	174	-	5"	25	-
SS 896/03	15	-	11	3	826	-	174	-	5"	29	-
SS 896/04	20	-	15	4	954	-	174	-	5"	32	-
SS 896/05	25	-	18,5	5	1082	-	174	-	5"	35	-
SS 896/06	30	-	22	6	1210	1221	174	182	5"	38	-
SS 896/07	40	40	30	7	1338	1349	174	182	5"	41	42
SS 896/08	40	40	30	8	1466	1477	174	182	5"	44	45
SS 896/09	50	50	37	9	1594	1605	174	182	5"	47	47
SS 896/10	50	50	37	10	1722	1733	174	182	5"	50	50
SS 896/11	60	60	45	11	1850	1861	174	182	5"	53	53
SS 896/12	60	60	45	12	1978	1989	174	182	5"	56	55
SS 896/13	-	70	52	13	-	2117	-	182	5"	-	58
SS 896/14	-	70	52	14	-	2245	-	182	5"	-	60
SS 896/15	-	75	55	15	-	2373	-	182	5"	-	63
SS 896/16	-	80	59	16	-	2501	-	182	5"	-	65
SS 896/17	-	90	66	17	-	2629	-	182	5"	-	68
SS 896/18	-	90	66	18	-	2757	-	182	5"	-	70
SS 896/19	-	100	75	19	-	2885	-	182	5"	-	73
SS 896/20	-	100	75	20	-	3013	-	182	5"	-	75
SS 896/21	-	110	81	21	-	3141	-	182	5"	-	78
SS 896/22	-	110	81	22	-	3269	-	182	5"	-	81
SS 896/23	-	125	92	23	-	3397	-	182	5"	-	83

MODELO	MOTOR			m³/h	CARGA DINÁMICA TOTAL (m)													
	6" HP	8" HP	kW		0	68	72	76	80	84	88	92	96	100	104	108	112	
					l / seg	0,00	18,89	20,00	21,11	22,22	23,33	24,44	25,56	26,67	27,78	28,89	30,00	31,11
				gpm	0	299	317	335	352	370	387	405	423	440	458	476	493	
SS 896/01	5,5	-	4		16	14	13	13	13	13	12	12	11	10	10	9	9	
SS 896/02	10	-	7,5		33	28	27	26	26	25	24	23	22	21	19	18	17	
SS 896/03	15	-	11		50	41	40	39	38	38	36	35	33	31	29	27	26	
SS 896/04	20	-	15		67	55	54	52	51	50	48	46	44	42	39	36	34	
SS 896/05	25	-	18,5		84	69	67	66	64	63	60	58	55	52	49	45	43	
SS 896/06	30	-	22		100	83	80	79	77	75	72	69	66	62	58	54	51	
SS 896/07	40	40	30		117	97	94	92	90	88	84	81	77	73	68	63	60	
SS 896/08	40	40	30		134	110	107	105	102	100	96	92	88	83	78	72	68	
SS 896/09	50	50	37		151	124	121	118	115	113	108	104	99	94	87	81	77	
SS 896/10	50	50	37		160	138	134	131	128	125	120	115	110	104	97	90	85	
SS 896/11	60	60	45		184	152	147	144	141	138	132	127	121	114	107	99	94	
SS 896/12	60	60	45		201	166	161	157	154	150	144	138	132	125	116	108	102	
SS 896/13	-	70	52		218	179	174	170	166	163	156	150	143	135	126	117	111	
SS 896/14	-	70	52		225	193	188	183	179	175	168	161	154	146	136	126	119	
SS 896/15	-	75	55		242	207	201	197	192	188	180	173	165	156	146	135	128	
SS 896/16	-	80	59		257	221	214	210	205	200	192	184	176	166	155	144	136	
SS 896/17	-	90	66		274	235	228	223	218	213	204	196	187	177	165	153	145	
SS 896/18	-	90	66		302	248	241	236	230	225	216	207	198	187	175	162	153	
SS 896/19	-	100	75		319	262	255	249	243	238	228	219	209	198	184	171	162	
SS 896/20	-	100	75		336	276	268	262	256	250	240	230	220	208	194	180	170	
SS 896/21	-	110	81		352	290	281	275	269	263	252	242	231	218	204	189	179	
SS 896/22	-	110	81		369	304	295	288	282	275	264	253	242	229	213	198	187	
SS 896/23	-	125	92		386	317	308	301	294	288	276	265	253	239	223	207	196	

Fecha 01/2013 | Rev 00

Franklin Electric reserva el derecho a modificar productos sin previo aviso.

SS 896



**BOMBAS DE ACERO
INOXIDABLE**
50 Hz

Curvas de Rendimiento - 01 a 23 etapas

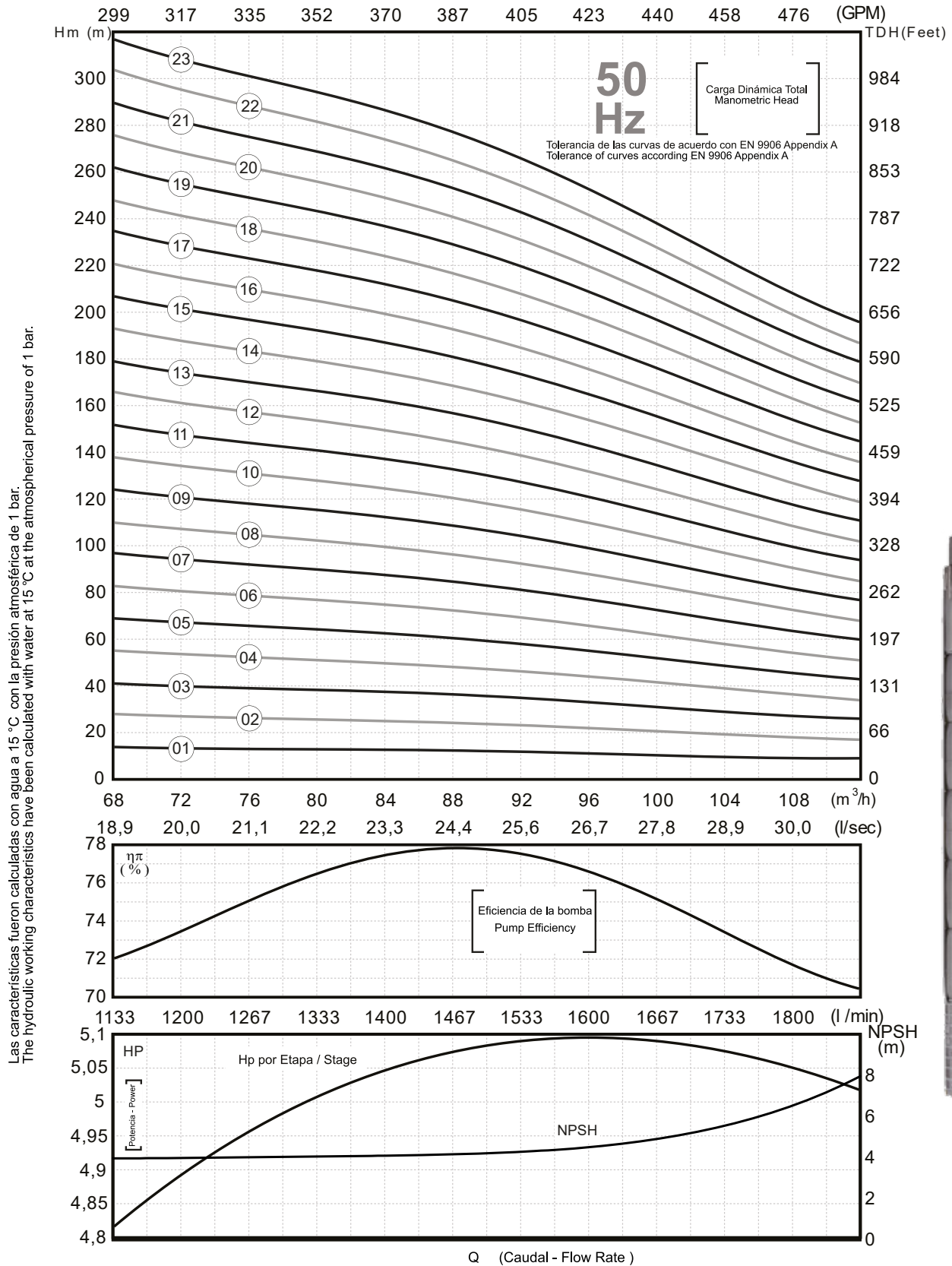

Desempeño de las curvas están basadas en la viscosidad $\nu = 1\text{mm}^2/\text{s}$ y densidad $\rho = 1000\text{kg}/\text{m}^3$
Performance curves are based on the kinematic viscosity $\nu = 1\text{mm}^2/\text{s}$ and density $\rho = 1000\text{kg}/\text{m}^3$

SS 872 | SS 896



BOMBAS DE ACERO INOXIDABLE
50 Hz

Componentes y Montaje

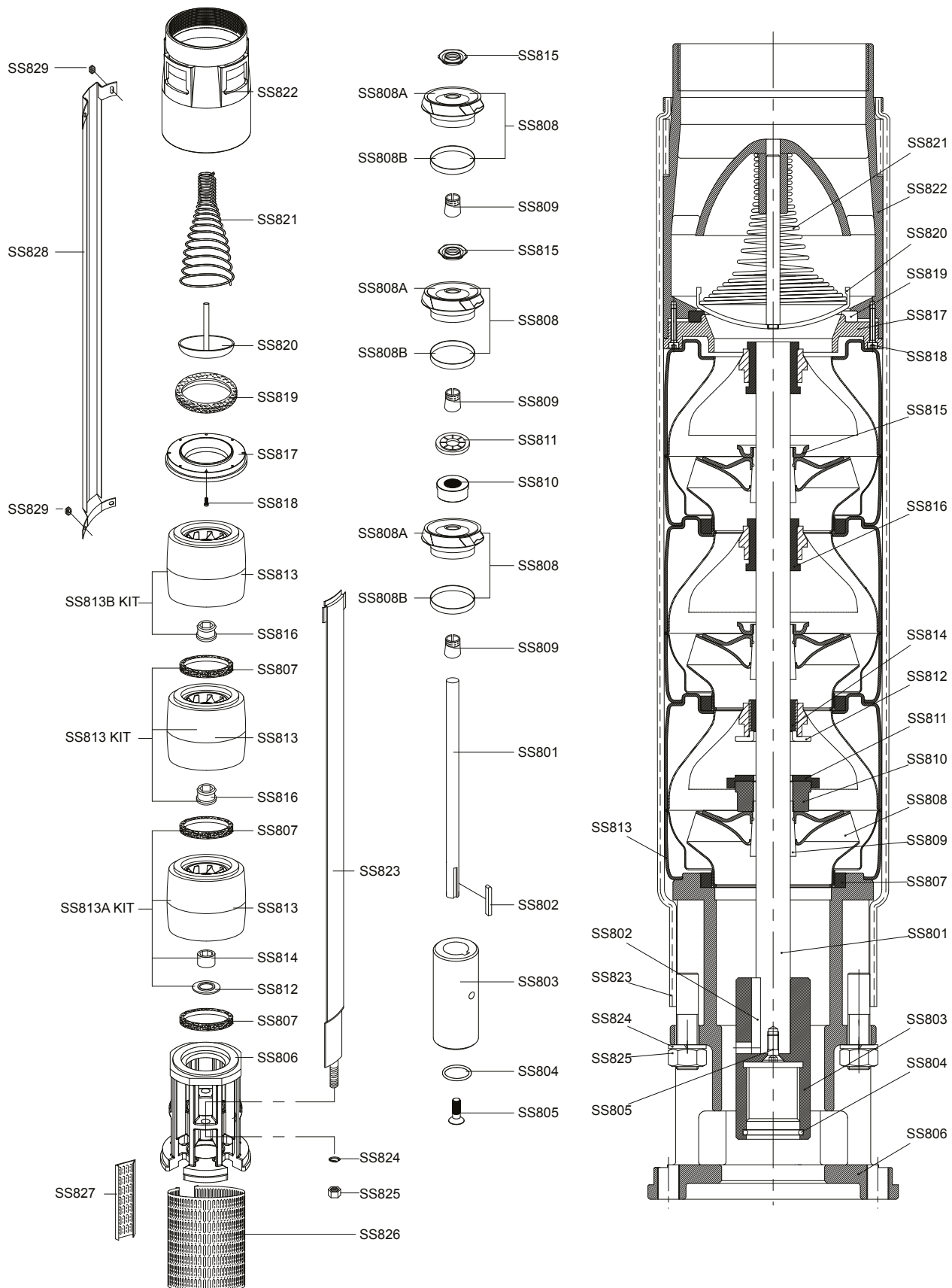

Lista de Componentes

Parte	Descripción	Material	Tipo
SS801	Eje	Acero Inoxidable	AISI 420
SS802	Chaveta	Acero Inoxidable	AISI 304
SS803	Acoplamiento	Acero Inoxidable	AISI 420
SS804	O-ring	Nitrilo	-
SS805	Tornillo del acoplamiento	Acero Inoxidable	AISI 304
SS806	Soporte	Acero Inoxidable	AISI 304
SS807	Anillo de Cuello	Nitrilo / Noryl	-
SS808A	Impulsor	Acero Inoxidable	AISI 304
SS808B	Anillo del Impulsor	Acero Inoxidable	AISI 304
SS809	Cono de Separación	Acero Inoxidable	AISI 420
SS810	Tuerca para Anillo de Retención	Acero Inoxidable	AISI 420
SS811	Arandela espaciadora para Anillo de Retención	Composito Termoplástico	-
SS812	Anillo de Retención	Acero Inoxidable	AISI 420
SS813	Difusor	Acero Inoxidable	AISI 304
SS813 A KIT	Difusor	Acero Inoxidable	AISI 304
	Casquillo del Buje del Difusor	Nitrilo / Noryl	-
	Buje	Nitrilo / Acero clase 42	-
	Anillo de Cuello	Acero Inoxidable	AISI 420
SS813 KIT	Difusor	Acero Inoxidable	AISI 304
	Buje	Nitrilo	-
	Casquillo del Buje del Difusor	Nitrilo / Noryl	-
SS813 B KIT	Difusor	Acero Inoxidable	AISI 304
	Buje	Nitrilo	-
SS814	Buje	Nitrilo / Acero clase 42	-
SS815	Tuerca de Cono de Separación	Acero Inoxidable	AISI 304
SS816	Buje	Nitrilo	-
SS817	Anillo de la Válvula	Acero Inoxidable	AISI 304
SS818	Tornillo de la Válvula	Acero Inoxidable	AISI 304
SS819	Asiento de Válvula	Nitrilo	-
SS820	Válvula del Cono	Acero Inoxidable	AISI 304
SS821	Resorte de la Válvula	Acero Inoxidable	AISI 304
SS822	Descarga (5" Normal)	Acero Inoxidable	AISI 304
SS823	Tirante	Acero Inoxidable	AISI 304
SS824	Arandela del Tirante	Acero Inoxidable	AISI 304
SS825	Tuerca del Tirante	Acero Inoxidable	AISI 304
SS826	Filtro	Acero Inoxidable	AISI 304
SS827	Seguro del filtro	Acero Inoxidable	AISI 304
SS828	Guardacable	Acero Inoxidable	AISI 304
SS829	Tornillo del Guardacable	Acero Inoxidable	AISI 304



eficiente
duradero
amplia gama

efficient
durable
wide range

FPS

10" W



FPS
serie SS

SS 10108



**BOMBAS DE ACERO
INOXIDABLE**
50 Hz

Especificaciones

- Rango de operación en 50hz: Q = 78 m³/h - 138 m³/h
 - Descarga: 6" con hilo en descarga 11 TPI
 - Tipo del impulsor: flujo mixto
 - Sentido de rotación: anti horaria
 - Conexión: según estándar NEMA
 - Diámetro del eje: 32mm
 - Diámetro máximo de la bomba: 208mm (incluyendo guarda cable)
- Estándares de seguridad y fabricación:
- TS 11146:2014
 - EN 809:1998+A1+2009+AC:2010

- Líquido a bombear: agua limpia
- Paso máximo de sólidos: 2 mm
- Concentración máxima de sólidos: 50 PPM
- Nivel mínimo de líquido (NPSH): 1200mm desde el fondo de la ranura de succión

2006/42/EC
EN ISO 12100:2010

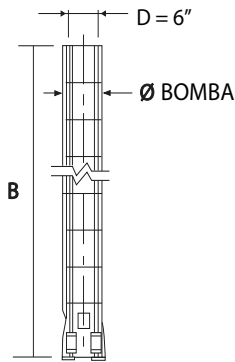

MODELO	MOTOR				ETAPAS	DIMENSIONES (mm)					PESO (kg)		
	6" HP	8" HP	10" RW CHAVETA HP	kW		10"-6" 10"-8" 10"-10"			Ø BOMBA	Ø D	BOMBA		
						B	B	B			10"-6"	10"-8"	10"-10"
SS 10108/01	10	-	-	7,5	1	608	-	-	208	6"	30	-	-
SS 10108/02	20	-	-	15	2	764	-	-	208	6"	36	-	-
SS 10108/03	30	-	-	22	3	920	920	-	208	6"	42	-	-
SS 10108/04	40	40	-	30	4	1076	1076	-	208	6"	48	50	-
SS 10108/05	50	50	-	37	5	1232	1232	-	208	6"	55	55	-
SS 10108/06	60	60	-	45	6	1388	1388	-	208	6"	61	62	-
SS 10108/07	-	70	-	52	7	-	1544	-	208	6"	-	68	-
SS 10108/08	-	80	-	59	8	-	1700	-	208	6"	-	74	-
SS 10108/09	-	90	-	66	9	-	1856	-	208	6"	-	80	-
SS 10108/10	-	100	-	75	10	-	2012	-	208	6"	-	86	-
SS 10108/11	-	110	-	81	11	-	2168	-	208	6"	-	92	-
SS 10108/12	-	125	-	92	12	-	2324	2324	208	6"	-	98	-
SS 10108/13	-	150	150	110	13	-	2480	2480	208	6"	-	104	104
SS 10108/14	-	150	150	110	14	-	2636	2636	208	6"	-	110	110
SS 10108/15	-	150	150	110	15	-	2792	2792	208	6"	-	116	116

MODELO	MOTOR				m ³ /h	0	78	84	90	100	108	115	125	135	145	
	6" HP	8" HP	10" RW CHAVETA HP	kW		l / seg	0,00	21,7	23,3	25,0	27,8	30,0	31,9	34,7	37,5	40,3
						gpm	0	343	370	396	440	476	506	550	594	638
SS 10108/01	10	-	-	7,5	CARGA DINÁMICA TOTAL (m)	25	22	21	20	20	19	18	16	15	13	
SS 10108/02	20	-	-	15		50	43	42	41	39	37	36	32	29	27	
SS 10108/03	30	-	-	22		74	65	62	61	59	56	53	49	44	40	
SS 10108/04	40	40	-	30		99	86	83	81	79	74	71	65	58	54	
SS 10108/05	50	50	-	37		124	108	104	102	99	93	89	81	73	67	
SS 10108/06	60	60	-	45		149	129	125	122	118	111	107	97	88	80	
SS 10108/07	-	70	-	52		173	151	145	142	138	130	125	114	102	94	
SS 10108/08	-	80	-	59		198	172	166	163	158	148	142	130	117	107	
SS 10108/09	-	90	-	66		223	194	187	183	178	167	160	146	131	121	
SS 10108/10	-	100	-	75		248	215	208	203	197	185	178	162	146	134	
SS 10108/11	-	110	-	81		273	237	228	224	217	204	196	179	161	148	
SS 10108/12	-	125	-	92		297	258	249	244	237	222	213	195	175	161	
SS 10108/13	-	150	150	110		322	280	270	265	257	241	231	211	190	174	
SS 10108/14	-	150	150	110		347	301	291	285	276	259	249	227	204	188	
SS 10108/15	-	150	150	110		372	323	311	305	296	278	267	244	219	201	

Fecha 03/2013 | Rev 02

Franklin Electric reserva el derecho a modificar productos sin previo aviso.

SS 10108



**BOMBAS DE ACERO
INOXIDABLE**
50 Hz

Curvas de Rendimiento - 01 a 15 etapas

Las características fueron calculadas con agua a 15 °C con la presión atmosférica de 1 bar.
The hydraulic working characteristics have been calculated with water at 15 °C at the atmospheric pressure of 1 bar.

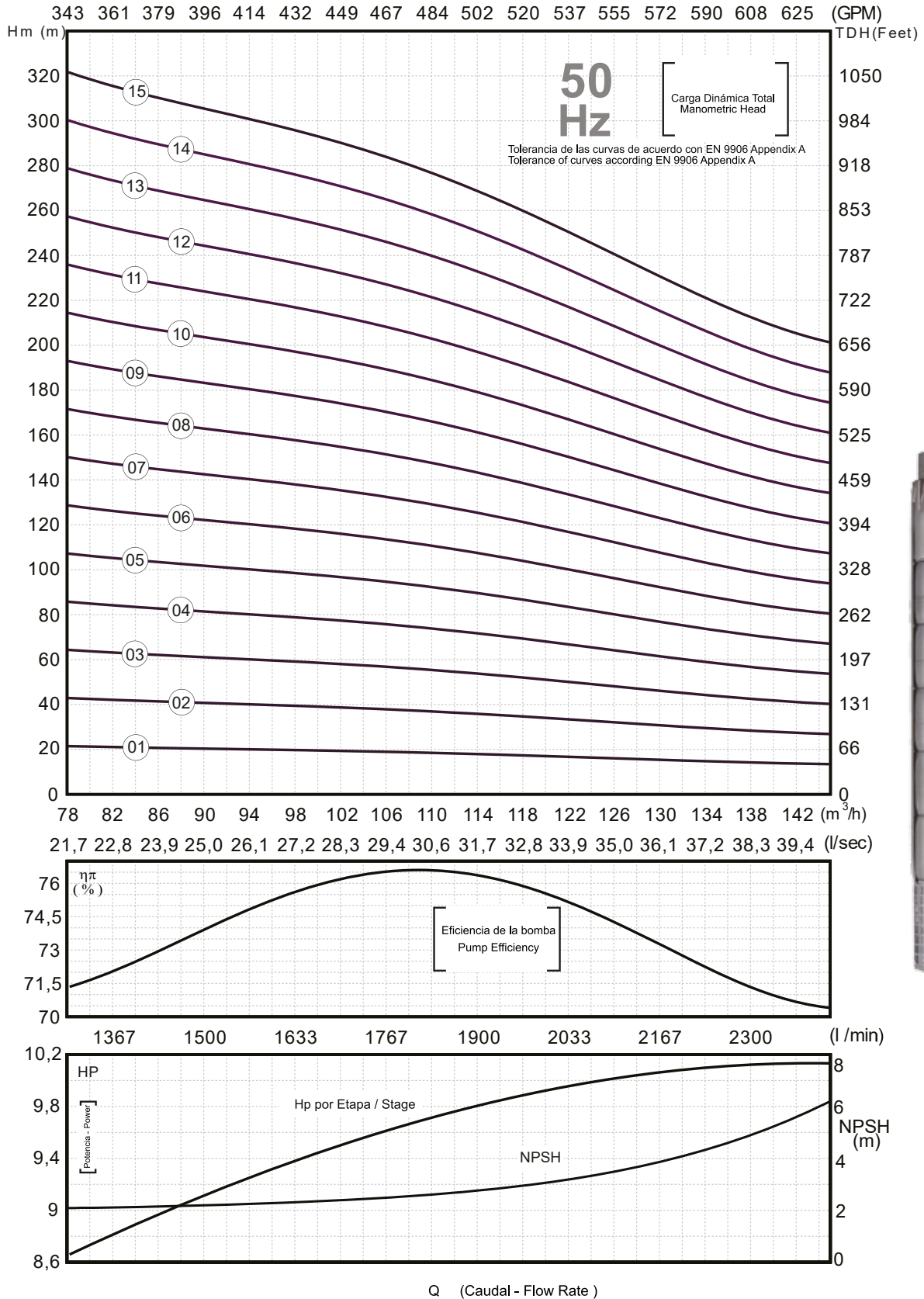

Desempeño de las curvas están basadas en la viscosidad $\nu = 1\text{mm}^2/\text{s}$ y densidad $\rho = 1000\text{ kg/m}^3$
Performance curves are based on the kinematic viscosity $\nu = 1\text{mm}^2/\text{s}$ and density $\rho = 1000\text{ kg/m}^3$

SS 10120



**BOMBAS DE ACERO
INOXIDABLE**
50 Hz

Especificaciones

- Rango de operación en 50hz: Q = 80 m³/h - 150 m³/h
- Descarga: 6" con hilo en descarga 11 TPI
- Tipo del impulsor: flujo mixto
- Sentido de rotación: anti horaria
- Conexión: según estándar NEMA
- Diámetro del eje: 32mm
- Diámetro máximo de la bomba: 208mm (incluyendo guarda cable)

- Líquido a bombear: agua limpia
- Paso máximo de sólidos: 2 mm
- Concentración máxima de sólidos: 50 PPM
- Nivel mínimo de líquido (NPSH): 1200mm desde el fondo de la ranura de succión

- Estándares de seguridad y fabricación:
- TS 11146:2014
- EN 809:1998+A1+2009+AC:2010
- 2006/42/EC
- EN ISO 12100:2010

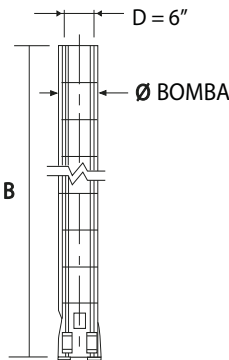

MOTOR	MOTOR				ETAPAS	DIMENSIONES (mm)					PESO (kg)		
	6" HP	8" HP	10" RW CHAVETA HP	kW		10"-6"			ø BOMBA	ø D	BOMBA		
						B	B	B			10"-6"	10"-8"	10"-10"
SS 10120/1A	10	-	-	7,5	1	608	-	-	208	6"	30	-	-
SS 10120/1	15	-	-	11	1	608	-	-	208	6"	30	-	-
SS 10120/2A	20	-	-	15	2	764	-	-	208	6"	36	-	-
SS 10120/2	30	-	-	22	2	764	764	-	208	6"	36	-	-
SS 10120/3AA	40	40	-	30	3	920	920	-	208	6"	42	42	-
SS 10120/3	40	40	-	30	3	920	920	-	208	6"	42	42	-
SS 10120/4AAA	50	50	-	37	4	1076	1076	-	208	6"	50	50	-
SS 10120/4AA	50	50	-	37	4	1076	1076	-	208	6"	50	50	-
SS 10120/4A	50	50	-	37	4	1076	1076	-	208	6"	50	50	-
SS 10120/4	60	60	-	45	4	1076	1076	-	208	6"	50	50	-
SS 10120/5AAA	60	60	-	45	5	1232	1232	-	208	6"	55	55	-
SS 10120/5AA	60	60	-	45	5	1232	1232	-	208	6"	55	55	-
SS 10120/5	-	70	-	52	5	-	1232	-	208	6"	-	55	-
SS 10120/6AAA	-	70	-	52	6	-	1388	-	208	6"	-	62	-
SS 10120/6AA	-	75	-	55	6	-	1388	-	208	6"	-	62	-
SS 10120/6	-	80	-	59	6	-	1388	-	208	6"	-	62	-
SS 10120/7AA	-	90	-	66	7	-	1544	-	208	6"	-	68	-
SS 10120/7A	-	90	-	66	7	-	1544	-	208	6"	-	68	-
SS 10120/7	-	100	-	75	7	-	1544	-	208	6"	-	68	-
SS 10120/8AAA	-	100	-	75	8	-	1700	-	208	6"	-	74	-
SS 10120/8AA	-	100	-	75	8	-	1700	-	208	6"	-	74	-
SS 10120/8	-	110	-	81	8	-	1700	-	208	6"	-	74	-
SS 10120/9AAA	-	110	-	81	9	-	1856	-	208	6"	-	80	-
SS 10120/9	-	125	-	92	9	-	1856	1856	208	6"	-	80	-
SS 10120/10AAA	-	125	-	92	10	-	2012	2012	208	6"	-	86	-
SS 10120/10AA	-	125	-	92	10	-	2012	2012	208	6"	-	86	-
SS 10120/10A	-	150	150	110	10	-	2012	2012	208	6"	-	86	86
SS 10120/10	-	150	150	110	10	-	2012	2012	208	6"	-	86	86
SS 10120/11	-	150	150	110	11	-	2168	2168	208	6"	-	92	92
SS 10120/12AAA	-	150	150	110	12	-	2324	2324	208	6"	-	99	99

MODELO	MOTOR				m³/h	CARGA DINÁMICA TOTAL (m)														
	6" HP	8" HP	10" RW CHAVETA HP	kW		0	80	90	100	110	120	125	130	135	140	145	150			
						l / seg	0,00	22,2	25,0	27,8	30,6	33,3	34,7	36,1	37,5	38,9	40,3	41,7		
SS 10120/1A	10	-	-	7,5	25	21	20	20	18	17	16	16	15	14	13	11				
SS 10120/1	15	-	-	11	29	25	24	23	22	21	21	20	19	18	18	17				
SS 10120/2A	20	-	-	15	53	46	45	43	41	38	37	36	34	32	31	28				
SS 10120/2	30	-	-	22	57	50	49	47	45	43	41	40	38	37	36	34				
SS 10120/3AA	40	40	-	30	78	68	65	63	59	56	53	51	48	46	45	40				
SS 10120/3	40	40	-	30	86	76	73	70	67	64	62	60	58	55	53	50				
SS 10120/4AAA	50	50	-	37	103	89	85	83	78	73	69	67	63	60	58	51				
SS 10120/4AA	50	50	-	37	107	93	90	86	82	77	74	71	68	65	62	56				
SS 10120/4A	50	50	-	37	111	97	94	90	86	81	78	76	72	69	67	62				
SS 10120/4	60	60	-	45	115	101	98	94	90	85	83	80	77	74	71	67				
SS 10120/5AAA	60	60	-	45	132	114	110	106	100	94	90	87	82	79	76	68				
SS 10120/5AA	60	60	-	45	136	118	114	110	104	98	94	91	87	83	80	73				
SS 10120/5	-	70	-	52	144	126	122	117	112	107	103	100	96	92	89	84				
SS 10120/6AAA	-	70	-	52	160	139	134	129	123	115	111	107	101	97	94	85				
SS 10120/6AA	-	75	-	55	164	143	138	133	127	120	115	111	106	102	98	90				
SS 10120/6	-	80	-	59	172	151	146	140	134	128	124	120	115	111	107	101				
SS 10120/7AA	-	90	-	66	193	169	163	156	149	141	136	131	125	120	116	107				
SS 10120/7A	-	90	-	66	197	173	167	160	153	145	140	136	130	125	120	113				
SS 10120/7	-	100	-	75	201	176	171	164	157	150	144	140	134	129	125	118				
SS 10120/8AAA	-	100	-	75	218	190	183	176	167	158	152	147	140	134	129	119				
SS 10120/8AA	-	100	-	75	222	194	187	180	171	162	156	151	144	139	134	124				
SS 10120/8	-	110	-	81	230	202	195	187	179	171	165	160	153	148	143	135				
SS 10120/9AAA	-	110	-	81	247	215	208	200	190	180	173	167	159	153	147	136				
SS 10120/9	-	125	-	92	258	227	220	211	202	192	186	180	173	166	160	152				
SS 10120/10AAA	-	125	-	92	275	240	232	223	212	201	193	187	178	171	165	153				
SS 10120/10AA	-	125	-	92	279	244	236	227	216	205	198	191	183	176	169	158				
SS 10120/10A	-	150	150	110	283	248	240	230	220	209	202	196	187	180	174	163				
SS 10120/10	-	150	150	110	287	252	244	234	224	214	206	200	192	185	178	169				
SS 10120/11	-	150	150	110	316	277	269	257	247	235	227	220	211	203	196	186				
SS 10120/12AAA	-	150	150	110	333	291	281	270	257	244	234	227	216	208	201	187				

SS 10120



**BOMBAS DE ACERO
INOXIDABLE**
50 Hz

Curvas de Rendimiento - 01 a 12 etapas

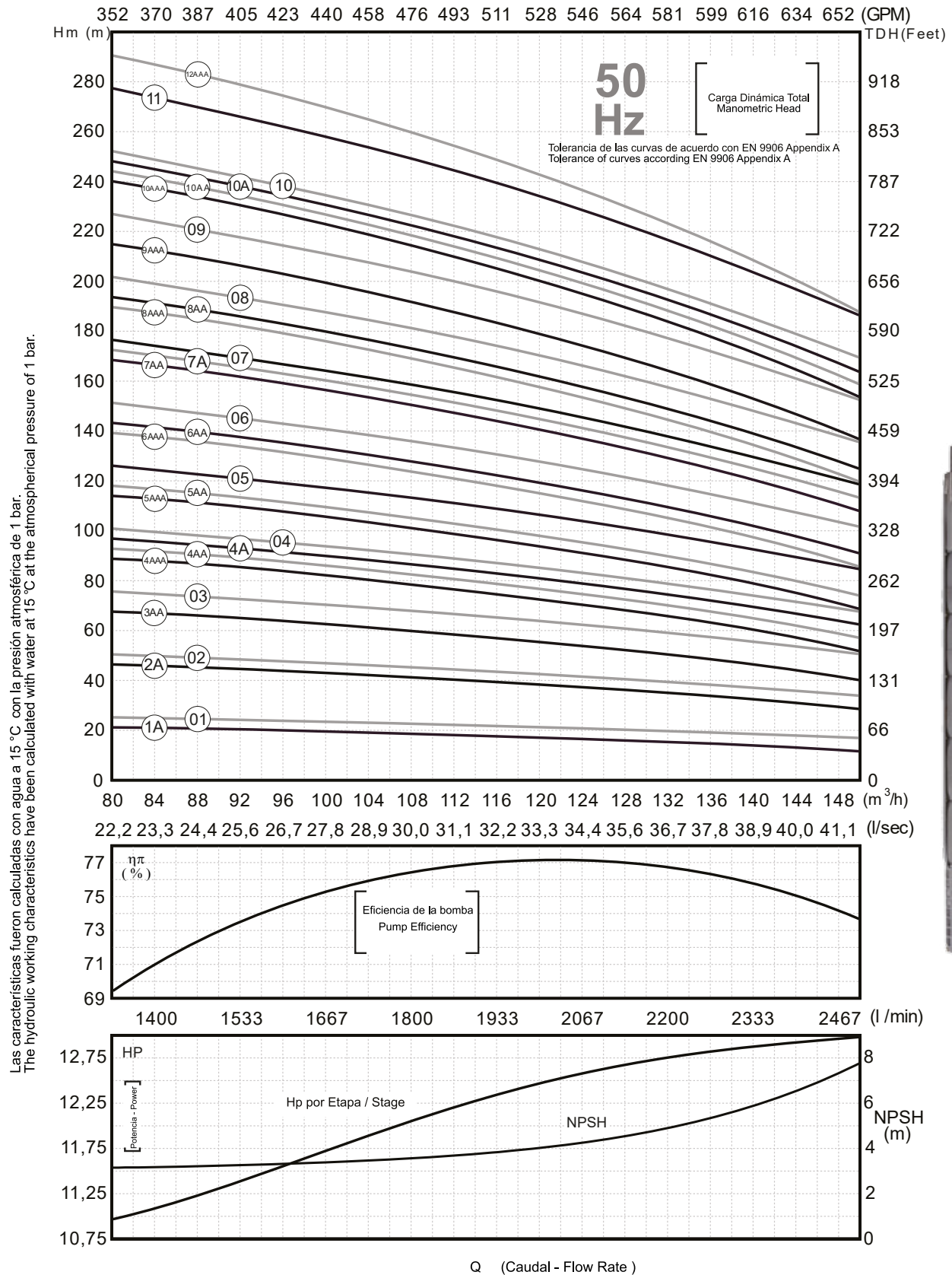

Desempeño de las curvas están basadas en la viscosidad $\nu = 1\text{mm}^2/\text{s}$ y densidad $\rho = 1000\text{ kg/m}^3$
Performance curves are based on the kinematic viscosity $\nu = 1\text{mm}^2/\text{s}$ and density $\rho = 1000\text{ kg/m}^3$

SS 10160



BOMBAS DE ACERO INOXIDABLE
50 Hz

Curvas de Rendimiento - 01 a 10 etapas

Las características fueron calculadas con agua a 15 °C. con la presión atmosférica de 1 bar.
The hydraulic working characteristics have been calculated with water at 15 °C at the atmospheric pressure of 1 bar.

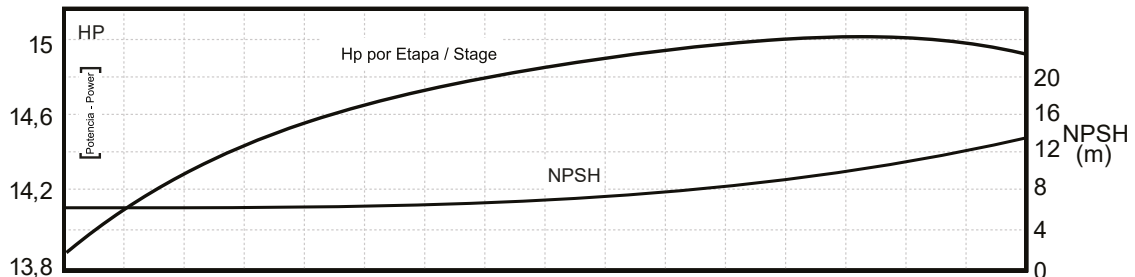
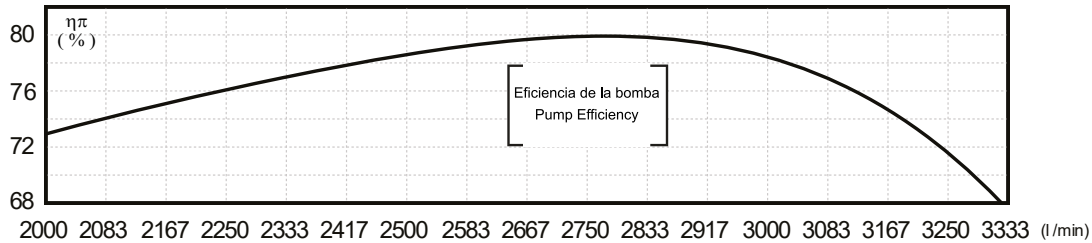
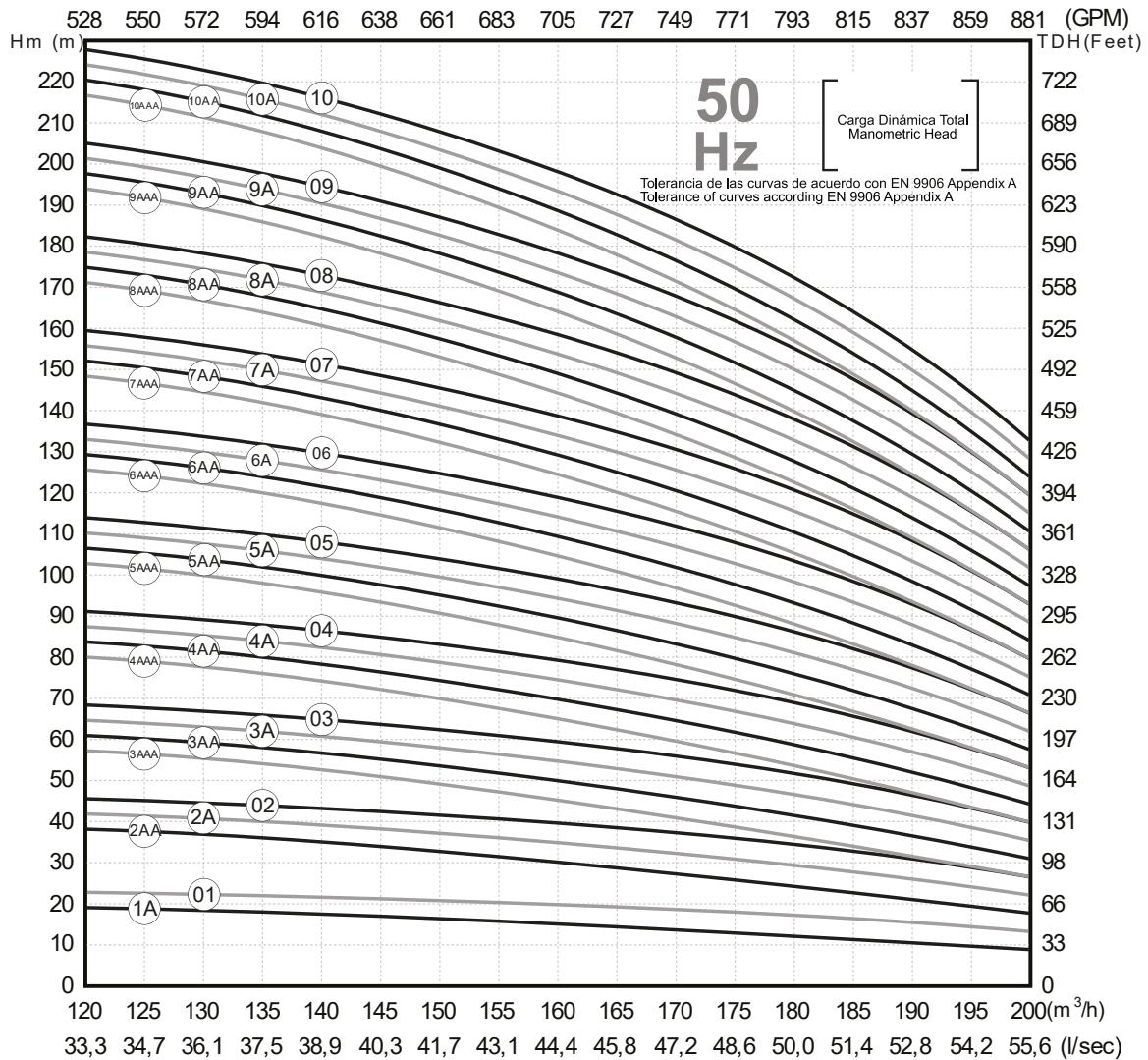

Q (Caudal - Flow Rate)

Desempeño de las curvas están basadas en la viscosidad $\nu = 1\text{mm}^2/\text{s}$ y densidad $\rho = 1000\text{ kg/m}^3$
Performance curves are based on the kinematic viscosity $\nu = 1\text{mm}^2/\text{s}$ and density $\rho = 1000\text{ kg/m}^3$



SS 10215



BOMBAS DE ACERO INOXIDABLE
50 Hz

Especificaciones

- Rango de operación en 50hz: Q = 150 m³/h - 270 m³/h
 - Descarga: 6" con hilo en descarga 11 TPI
 - Tipo del impulsor: flujo mixto
 - Sentido de rotación: anti horaria
 - Conexión: según estándar NEMA
 - Diámetro del eje: 45mm
 - Diámetro máximo de la bomba: 232mm (incluyendo guarda cable)
- Estándares de seguridad y fabricación:
 - TS 11146:2014
 - EN 809:1998+A1+2009+AC:2010

2006/42/EC
EN ISO 12100:2010

- Líquido a bombear: agua limpia
- Paso máximo de sólidos: 2 mm
- Concentración máxima de sólidos: 50 PPM
- Nivel mínimo de líquido (NPSH): 1200mm desde el fondo de la ranura de succión

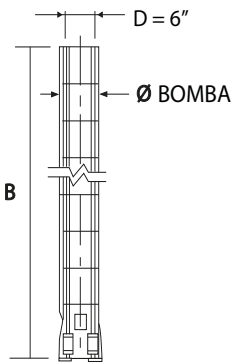

MODELO	MOTOR			ETAPAS	DIMENSIONES (mm)			PESO (kg)	
	8" HP	10" RW CHAVETA HP	kW		10" B	Ø BOMBA	Ø D	BOMBA	
								10"-8"	10"-10"
SS 10215/2AA	40	-	30	2	952	232	6"	60,7	60,7
SS 10215/02	50	-	37	2	952	232	6"	60,7	60,7
SS 10215/3AAA	60	-	45	3	1128	232	6"	69,8	69,8
SS 10215/03A	70	-	52	3	1128	232	6"	69,8	69,8
SS 10215/03	75	-	55	3	1128	232	6"	69,8	69,8
SS 10215/04AAAA	80	-	59	4	1304	232	6"	78,9	78,9
SS 10215/04AA	90	-	66	4	1304	232	6"	78,9	78,9
SS 10215/04	100	-	75	4	1304	232	6"	78,9	78,9
SS 10215/05AAA	110	-	81	5	1480	232	6"	88	88
SS 10215/05	125	-	92	5	1480	232	6"	88	88
SS 10215/06	150	150	110	6	1656	232	6"	97,1	97,1
SS 10215/07	-	200	147	7	1832	232	6"	106,2	106,2
SS 10215/08	-	200	147	8	2008	232	6"	115,3	115,3
SS 10215/10	-	250	185	10	2184	232	6"	124,4	124,4

PUMP TYPE	MOTOR			m ³ /h	CARGA DINÁMICA TOTAL (m)													
	8" HP	10" RW CHAVETA HP	kW		l / seg	0	150	170	190	200	205	210	215	220	225	230	250	270
				gpm	0,00	41,67	47,22	52,78	55,56	56,94	58,33	59,72	61,11	62,50	63,89	69,44	75,00	
SS 10215/2AA	40	-	30	71	51	48	45	42	41	40	39	38	36	35	27	20		
SS 10215/02	50	-	37	84	61	57	55	53	52	51	50	49	48	46	40	33		
SS 10215/3AAA	60	-	45	107	77	72	67	63	61	60	58	56	55	52	41	30		
SS 10215/03A	70	-	52	119	87	81	77	74	73	71	69	68	66	63	54	43		
SS 10215/03	75	-	55	126	92	86	82	80	78	77	75	73	72	69	60	49		
SS 10215/04AAAA	80	-	59	142	103	96	89	85	82	79	78	75	73	69	55	40		
SS 10215/04AA	90	-	66	155	113	105	99	95	93	91	89	87	84	81	68	53		
SS 10215/04	100	-	75	168	122	115	109	106	105	103	100	98	96	92	80	66		
SS 10215/05AAA	110	-	81	190	138	129	122	116	114	111	108	105	103	98	81	63		
SS 10215/05	125	-	92	209	153	143	137	133	131	128	125	122	120	116	100	82		
SS 10215/06	150	150	110	251	184	172	164	159	157	154	150	147	144	139	121	99		
SS 10215/07	-	200	147	293	214	200	191	186	183	179	175	171	168	162	141	115		
SS 10215/08	-	200	147	335	245	229	219	212	209	205	200	196	192	185	161	131		
SS 10215/10	-	250	185	419	306	286	273	265	261	256	250	245	240	231	201	164		

Fecha 03/2016 | Rev 01

Franklin Electric reserva el derecho a modificar productos sin previo aviso.

SS 10215



BOMBAS DE ACERO INOXIDABLE
50 Hz

Curvas de Rendimiento - 02 a 10 etapas

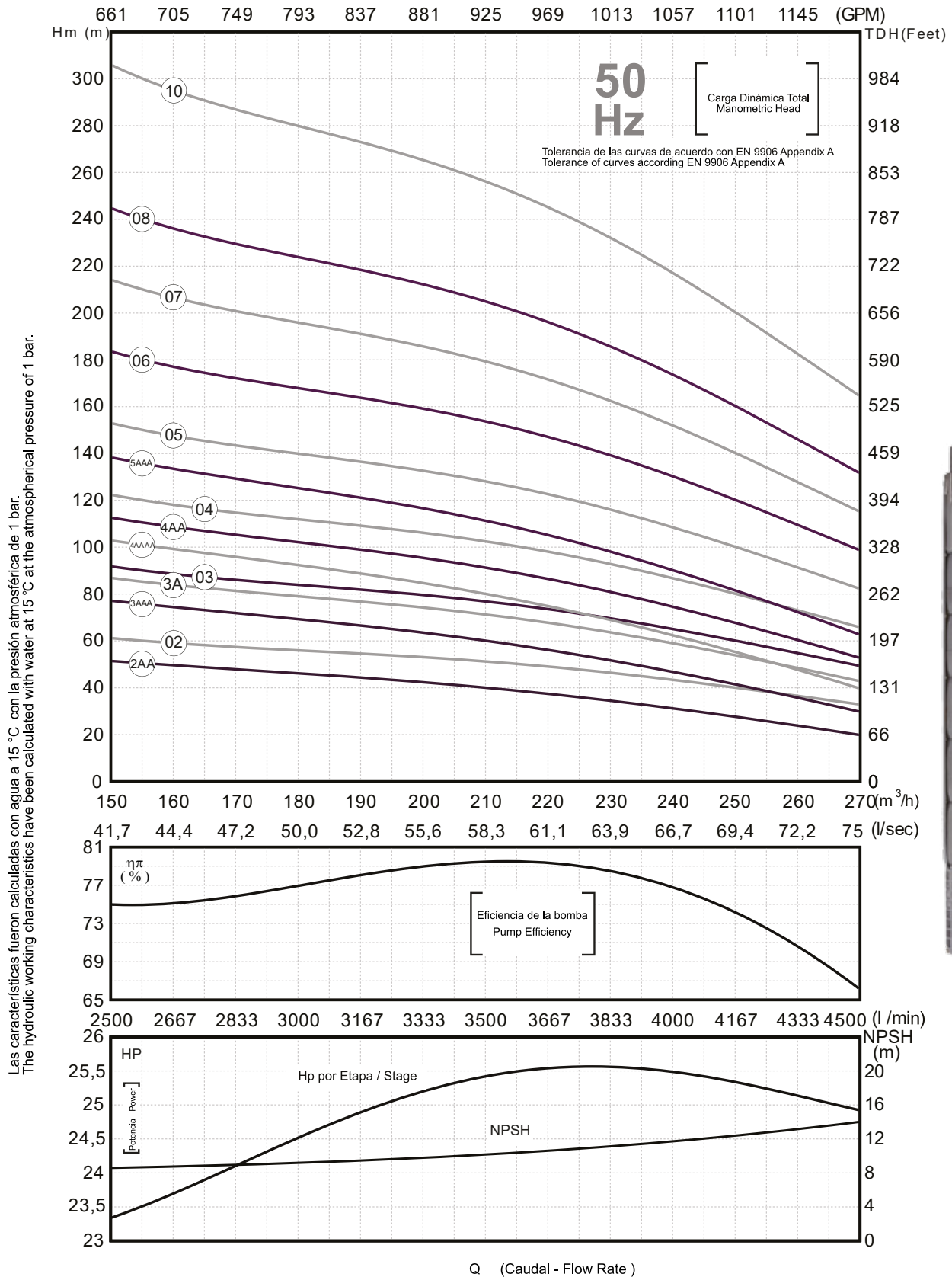

Desempeño de las curvas están basadas en la viscosidad $\nu = 1\text{mm}^2/\text{s}$ y densidad $\rho = 1000\text{ kg/m}^3$
Performance curves are based on the kinematic viscosity $\nu = 1\text{mm}^2/\text{s}$ and density $\rho = 1000\text{ kg/m}^3$

Componentes y Montaje

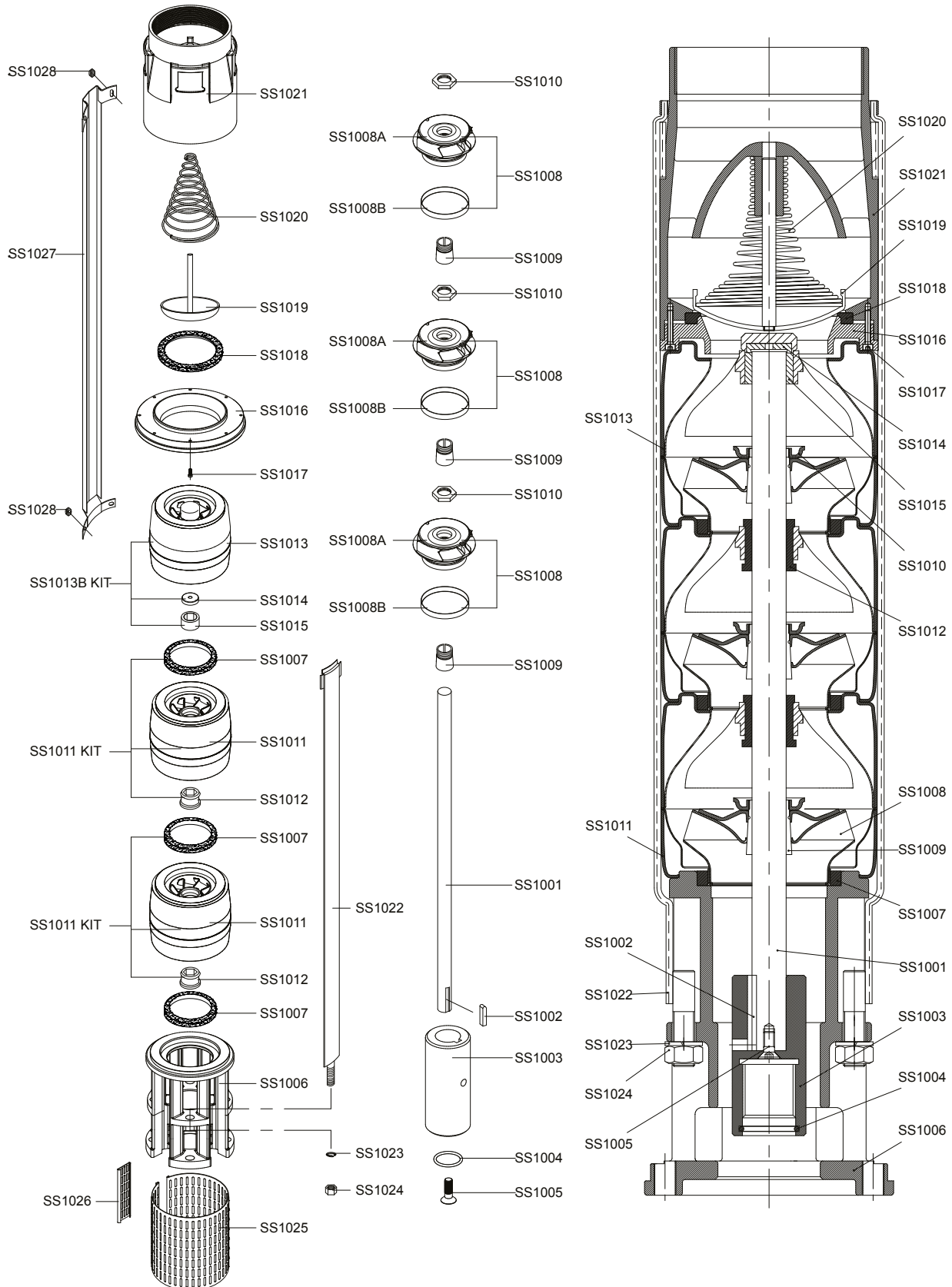

Lista de Componentes

Parte	Descripción	Material	Tipo
SS1001	Eje	Acero Inoxidable	AISI 420
SS1002	Chaveta	Acero Inoxidable	AISI 304
SS1003	Acoplamiento	Acero Inoxidable	AISI 420
SS1004	O-ring	Nitrilo	-
SS1005	Tornillo del acoplamiento	Acero Inoxidable	AISI 304
SS1006	Soporte	Acero Inoxidable	AISI 304
SS1007	Anillo de Cuello	Nitrilo / Noryl	-
SS1008A	Impulsor	Acero Inoxidable	AISI 304
SS1008B	Anillo del Impulsor	Acero Inoxidable	AISI 304
SS1009	Cono de Separación	Acero Inoxidable	AISI 420
SS1010	Tuerca para Cono de Separación	Acero Inoxidable	AISI 304
SS1011	Difusor	Acero Inoxidable	AISI 304
SS1011 KIT	Difusor	Acero Inoxidable	AISI 304
	Casquillo del Buje del Difusor	Nitrilo / Noryl	-
	Buje	Nitrilo	-
SS1012	Buje	Nitrilo	-
SS1013	Difusor para Descarga	Acero Inoxidable	AISI 304
SS1013 KIT	Difusor para Descarga	Acero Inoxidable	AISI 304
	Buje	Nitrilo / Acero clase 42	-
	Arandela espaciadora para Anillo de Retención	Composito Termoplástico	-
SS1014	Arandela espaciadora para Anillo de Retención	Composito Termoplástico	-
SS1015	Buje	Nitrilo / Acero clase 42	-
SS1016	Anillo de la Válvula	Acero Inoxidable	AISI 304
SS1017	Tornillo de la Válvula	Acero Inoxidable	AISI 304
SS1018	Asiento de Válvula	Nitrilo	-
SS1019	Válvula del Cono	Acero Inoxidable	AISI 304
SS1020	Resorte de la Válvula	Acero Inoxidable	AISI 304
SS1021	Descarga (6" Normal)	Acero Inoxidable	AISI 304
SS1022	Tirante	Acero Inoxidable	AISI 304
SS1023	Arandela del Tirante	Acero Inoxidable	AISI 304
SS1024	Tuerca del Tirante	Acero Inoxidable	AISI 304
SS1025	Filtro	Acero Inoxidable	AISI 304
SS1026	Seguro del filtro	Acero Inoxidable	AISI 304
SS1027	Guardacable	Acero Inoxidable	AISI 304
SS1028	Tornillo del Guardacable	Acero Inoxidable	AISI 304

SS 10215



**BOMBAS DE ACERO
INOXIDABLE**
50 Hz

Componentes y Montaje

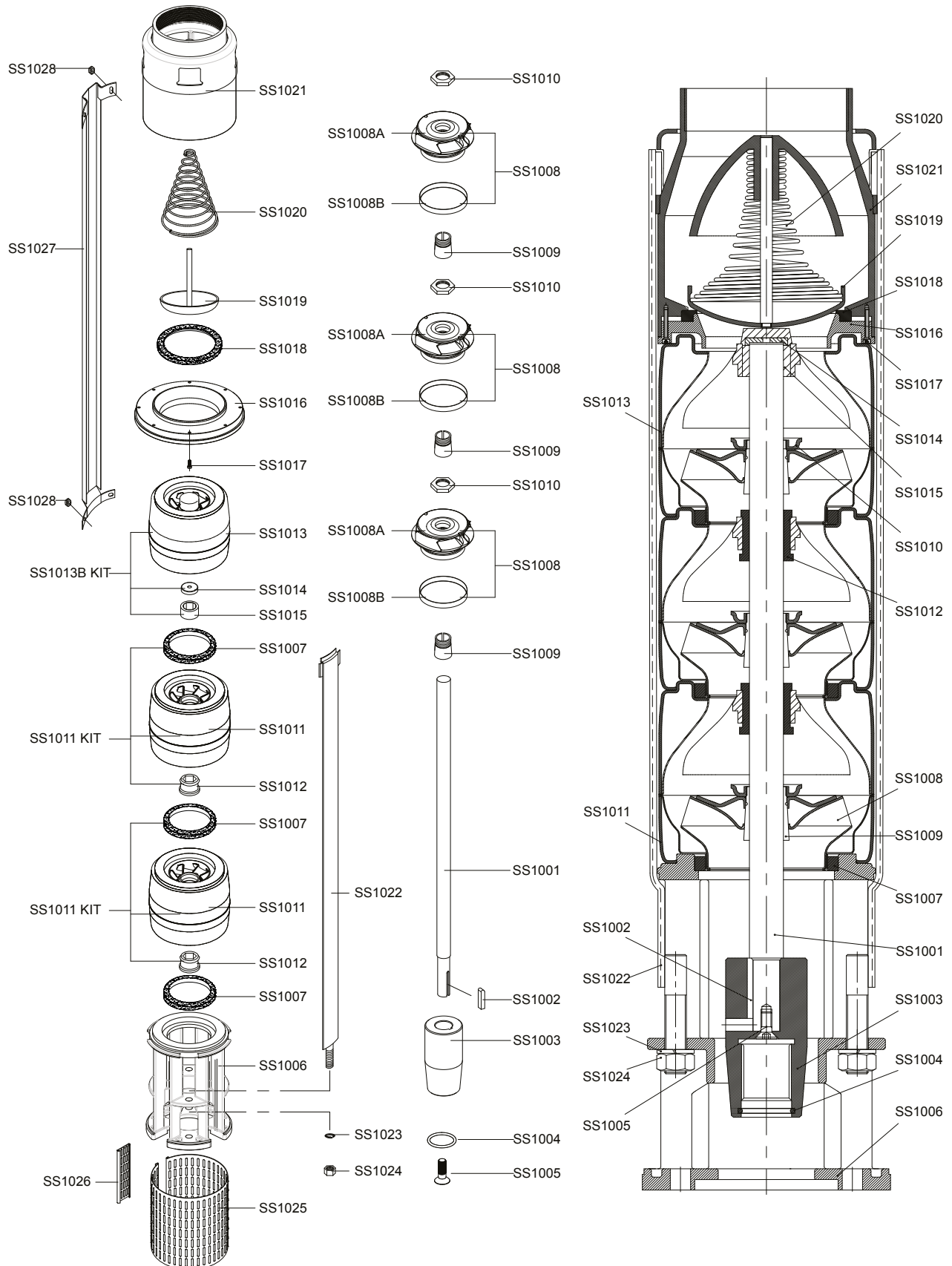

SS 10215



**BOMBAS DE ACERO
INOXIDABLE**
50 Hz

Lista de Componentes

Parte	Descripción	Material	Tipo
SS1001	Eje	Acero Inoxidable	AISI 420
SS1002	Chaveta	Acero Inoxidable	AISI 304
SS1003	Acoplamiento	Acero Inoxidable	AISI 420
SS1004	O-ring	Nitrilo	-
SS1005	Tornillo del acoplamiento	Acero Inoxidable	AISI 304
SS1006	Soporte	Acero Inoxidable	AISI 304
SS1007	Anillo de Cuello	Nitrilo / Noryl	-
SS1008A	Impulsor	Acero Inoxidable	AISI 304
SS1008B	Anillo del Impulsor	Acero Inoxidable	AISI 304
SS1009	Cono de Separación	Acero Inoxidable	AISI 420
SS1010	Tuerca para Cono de Separación	Acero Inoxidable	AISI 304
SS1011	Difusor	Acero Inoxidable	AISI 304
SS1011 KIT	Difusor	Acero Inoxidable	AISI 304
	Casquillo del Buje del Difusor	Nitrilo / Noryl	-
	Buje	Nitrilo	-
SS1012	Buje	Nitrilo	-
SS1013	Difusor para Descarga	Acero Inoxidable	AISI 304
SS1013 KIT	Difusor para Descarga	Acero Inoxidable	AISI 304
	Buje	Nitrilo / Acero clase 42	-
	Arandela espaciadora para Anillo de Retención	Composito Termoplástico	-
	SS1014	Arandela espaciadora para Anillo de Retención	Composito Termoplástico
SS1015	Buje	Nitrilo / Acero clase 42	-
SS1016	Anillo de la Válvula	Acero Inoxidable	AISI 304
SS1017	Tornillo de la Válvula	Acero Inoxidable	AISI 304
SS1018	Asiento de Válvula	Nitrilo	-
SS1019	Válvula del Cono	Acero Inoxidable	AISI 304
SS1020	Resorte de la Válvula	Acero Inoxidable	AISI 304
SS1021	Descarga (6" Normal)	Acero Inoxidable	AISI 304
SS1022	Tirante	Acero Inoxidable	AISI 304
SS1023	Arandela del Tirante	Acero Inoxidable	AISI 304
SS1024	Tuerca del Tirante	Acero Inoxidable	AISI 304
SS1025	Filtro	Acero Inoxidable	AISI 304
SS1026	Seguro del filtro	Acero Inoxidable	AISI 304
SS1027	Guardacable	Acero Inoxidable	AISI 304
SS1028	Tornillo del Guardacable	Acero Inoxidable	AISI 304



Franklin Electric

Franklin Electric Chile Limitada.
Lo Echevers 550, Bodega 1. Quilicura.
Santiago. Chile. Teléfono: +562 2896.9340
www.franklinwater.cl