

# Franklin Electric Europa GmbH

## 10" Rewindable Motors

### Product Information and Service



**Franklin Electric**

# QUALITY IN THE WELL

POWERED BY



Franklin Electric



QUALITY



AVAILABILITY



SERVICE



INNOVATION





## Table of contents

### 10" Rewindable Motors

Standard .....	4 - 12
----------------	--------

### Accessories

Motor Filling Liquid .....	13
Motor Filling Kit .....	13
PT100 6" / 8" / 10" / 12" Rewindable Motors .....	14



# 10" Rewindable Motors

## 10" Rewindable Motors



### Submersible Motors

#### Quality in the Well

These 10" rewindable motors, manufactured in ISO 9001 certified facilities, are built for dependable operation in 10" diameter or larger water wells.

It is fitted with water lubricated radial and thrust bearings for maintenance-free operation. The motor is filled with a special FES93 fluid, providing frost protection down to -15°C storage temperature.

A special diaphragm ensures pressure compensation inside the motor. The Sand fighter® SiC seal system is standard. For applications in aggressive media, motors made of 316SS and 904L are available.

#### Product advantages:

- Easy to assemble with double flange
- Cable material according to drinking water regulations (VDE / ACS / KTW approved)
- Sand fighter® SiC seal system for high performance in sand
- High efficiency electrical design for low operation cost
- All motors prefilled and 100% tested
- Max. storage temperature -15°C - + 60°C
- Design for retrofittable PT100 sensor
- Non contaminating FES 93 filled design

#### Technical Specifications

##### Standard Motor:

- 85,0 - 185,0kW
- 10" flange
- Protection: IP 68
- Starts per hour: max. 10
- Installation position: vertical / horizontal (**185 kW** motors may not be installed horizontally)
- Motor Lead in 6 m length (KTW approved)
- Standard Voltage: 380-415V/50Hz, 460V/60Hz
- Voltage tolerance 50Hz: -10% / +6%  $U_N$  [380-415V = (380-10%) – (415+6%)]
- Voltage tolerance 60Hz:  $\pm 10\% U_N$
- Motor protection: Select thermal overloads according to EN 61947-4-1
- Standard motor with PVC winding insulation for max. ambient temperature of 25°C with a min. cooling flow:  $v = 0,5$  m/s

#### Options

- Other voltages
- YΔ - start (pos. of cables 90°)
- Motors in complete 316 SS and 904 L
- PE2/PA winding insulation for max. ambient temp. of 45°C at the same cooling conditions as standard
- PT 100 temperature sensor (sold separately)
- Lead in different lengths up to 50m

# 10" Rewindable Motors



## 10" Rewindable Motors - Model Numbers 50/60Hz \*

P <sub>N</sub> [kW]	U <sub>N</sub> / f	Model Numbers Digit 1 – 6		Model Numbers Digit 7 – 10					
	[V] / [Hz]	DOL	YΔ	304	316 SS	904L	PE2/PA		
							304	316 SS	904L
85	380 - 415 / 50 460 / 60	264 131	264 231	5111	6111	7111	53**	63**	73**
	380 / 60	264 661	264 761						
110	380 - 415 / 50 460 / 60	264 133	264 233	5111	6111	7111	53**	63**	73**
	380 / 60	264 663	264 763						
130	380 - 415 / 50 460 / 60	264 134	264 234	5111	6111	7111	53**	63**	73**
	380 / 60	264 664	264 764						
150	380 - 415 / 50 460 / 60		264 235	5111	6111	7111	53**	63**	73**
	380 / 60		264 765						
185	380 - 415 / 50 460 / 60		264 236	5111	6111	7111	53**	63**	73**
	380 / 60		264 766						

\* For VFD Operation is PE2/PA mandatory!



# 10" Rewindable Motors

## 10" Rewindable Motors - Performance Data 50Hz

P <sub>N</sub> [kW]	Thrust F [N]	U <sub>N</sub> [V]	n <sub>N</sub> [min <sup>-1</sup> ]	I <sub>N</sub> [A]	I <sub>A</sub> [A]	η (Eff.) [%] at % load			cos φ (PF) at % load			T <sub>N</sub> [Nm]	T <sub>A</sub> [Nm]
						50	75	100	50	75	100		
						85	60 000	380	2890	179	783		
400	2900	174	828	83	85			85	0,72	0,81	0,85	280	316
415	2910	171	863	83	85			85	0,68	0,78	0,83	279	342
500	2890	136	595	84	85			84	0,78	0,84	0,87	281	282
525	2900	133	631	83	85			85	0,72	0,81	0,85	280	316
1000	2900	68	331	83	85			85	0,72	0,81	0,85	280	316
110	60 000	380	2910	235	1095	86	87	86	0,72	0,81	0,85	361	418
		400	2920	232	1158	84	86	86	0,65	0,76	0,82	360	467
		415	2920	233	1206	83	85	86	0,59	0,71	0,79	360	507
		500	2910	180	875	86	87	86	0,69	0,79	0,83	360	432
		525	2920	179	923	85	86	86	0,62	0,73	0,80	359	482
		1000	2920	89	463	84	86	86	0,65	0,76	0,82	360	467
130	60 000	380	2900	266	1271	88	88	87	0,79	0,85	0,87	428	487
		400	2920	256	1344	87	88	88	0,74	0,82	0,86	425	546
		415	2920	255	1400	87	88	87	0,69	0,78	0,83	425	592
		500	2900	202	966	87	88	87	0,79	0,85	0,87	428	487
		525	2920	195	1024	87	88	87	0,73	0,81	0,85	425	546
		1000	2910	104	523	87	88	87	0,76	0,83	0,86	426	516
150	60 000	380	2910	307	1502	87	87	86	0,79	0,85	0,88	492	568
		400	2920	298	1590	86	88	87	0,73	0,81	0,85	491	635
		415	2930	296	1655	86	87	87	0,67	0,77	0,83	489	689
		500	2910	233	1142	87	87	86	0,79	0,85	0,88	492	568
		525	2920	227	1211	86	87	87	0,73	0,81	0,85	491	635
		1000	2920	117	636	86	88	87	0,73	0,81	0,85	491	635
185	60 000	380	2900	390	2030	87	88	87	0,72	0,81	0,85	609	913
		400	2920	384	2148	86	88	88	0,64	0,75	0,81	605	1022
		415	2920	389	2237	84	86	86	0,57	0,70	0,79	605	1109
		500	2900	294	1500	87	88	87	0,72	0,81	0,85	610	888
		525	2910	289	1580	86	87	87	0,65	0,76	0,82	607	988
		1000	2900	148	859	87	88	87	0,72	0,81	0,85	609	913

## 10" Rewindable Motors - Performance Data 60Hz

P <sub>N</sub> [kW]	P <sub>max</sub> [kW]	Thrust F [N]	U <sub>N</sub> [V]	n <sub>N</sub> [min <sup>-1</sup> ]	I <sub>max</sub> [A]	I <sub>A</sub> [A]	η <sub>max</sub> (Eff.) [%] at % load			cos φ <sub>max</sub> (PF) at % load			T <sub>max</sub> [Nm]	T <sub>A</sub> [Nm]
							50	75	100	50	75	100		
							85	98	60 000	460	3500	172		
380	3510	216	1120	82	84	85				0,69	0,78	0,83	267	325
110	127	60 000	460	3510	225	1160	84	86	86	0,71	0,80	0,84	345	375
			380	3510	273	1430	84	86	86	0,70	0,79	0,84	346	382
130	149	60 000	460	3510	254	1308	86	87	87	0,77	0,84	0,87	408	437
			380	3510	309	1710	85	87	86	0,73	0,82	0,86	408	474
150	173	60 000	460	3510	294	1557	85	87	87	0,77	0,84	0,87	469	508
			380	3510	362	1980	85	87	87	0,75	0,83	0,86	468	535
185	213	60 000	460	3510	377	2130	85	87	87	0,70	0,79	0,84	585	858
			380	3510	448	2690	84	87	87	0,66	0,77	0,87	583	896



## 10" Rewindable De-Rating Curves

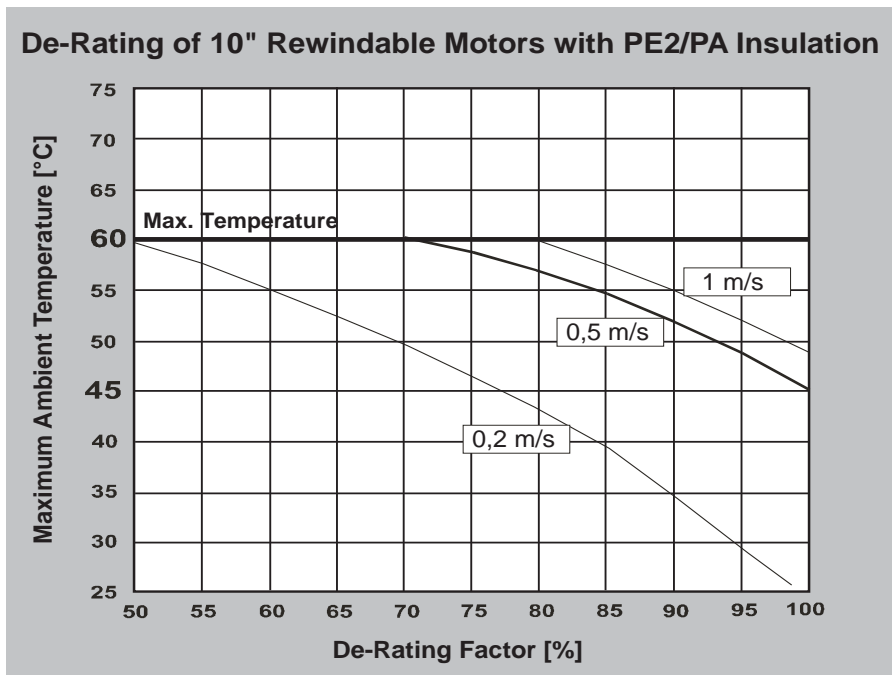
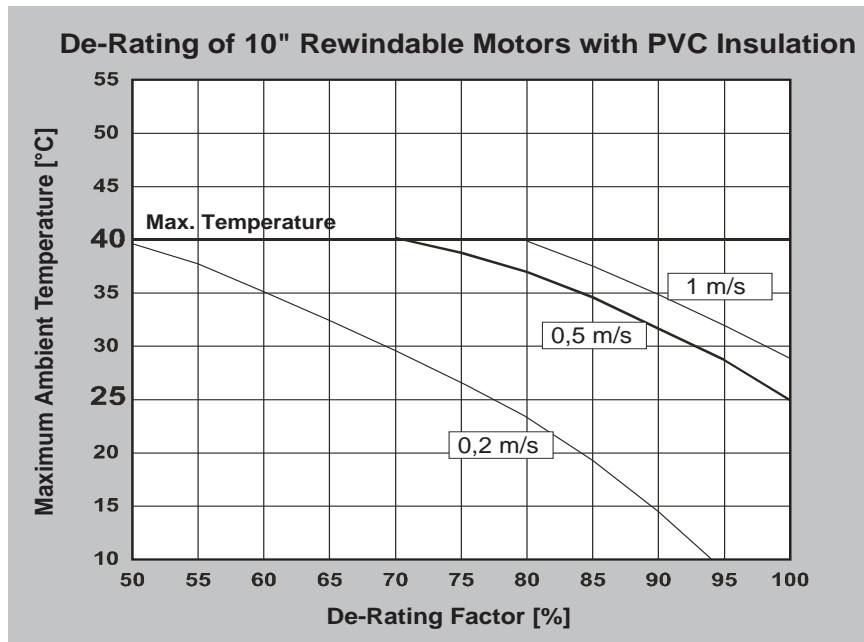



**If these conditions are not met please contact Franklin Electric !**

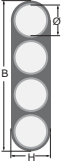
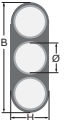

# 10" Rewindable Motors

## 10" Rewindable Motors - Motor Leads\*

DOL									
Lead	kW	Ø (mm <sup>2</sup> )	B / H (mm)		Lengths (m)	Qty.	Lead Mod.- Nr.	Lead seal Kit 304 / 316 Mod.- Nr.	Lead seal Kit 904L Mod.- Nr.
	85	4G25	B	44,3	6	1	308 710 116	308 660 720	308 660 724
			H	14,5					
	110 – 130	4G35	B	48,5	6	1	308 710 117	308 660 721	308 660 725
			H	16,5					
	130 - 150 (PE2/PA)	3X50	B	46,5	6	1	308 710 113	308 660 712	308 660 726
			H	19,5					
Ground lead (optional)	kW	Ø mm <sup>2</sup>	D (mm)		Lengths m	St.	Mod.-Nr.		
		1G25	13,0		8	1	308 053 080		

For PE2/PA engines additionally the special Tape **700 541 688** is absolutely necessary

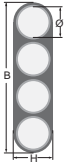
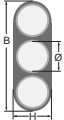
YΔ									
Lead	kW	Ø (mm <sup>2</sup> )	B / H (mm)		Lengths (m)	Qty.	Lead Mod.- Nr.	Lead seal Kit 304 / 316 Mod.- Nr.	Lead seal Kit 904L Mod.- Nr.
 	85	3X16	B	28,8	6	1	308 710 118	308 660 722	308 660 727
			H	12,2					
		4G16	B	38,0		1			
			H	12,8					
	110 - 150	3X25	B	37,5	6	1	308 710 114	308 660 713	308 660 728
			H	16					
		4G25	B	44,3		1			
			H	14,5					
185	4G35	B	48,5	6	1	308 710 121	308 660 723	308 660 729	
		H	16,5						
	3X35	B	38,5		1				
		H	16,5						

For PE2/PA engines additionally the special Tape **700 541 688** is absolutely necessary

Lead opening seal kit	85 – 185 kW DOL / YΔ	304 / 316	308 660 715
		904L	308 660 730

\*Cables are designed for submerged operation. For air operation please consult Franklin Electric.



# 10" Rewindable Motors



## Electrical Connection

**DOL**

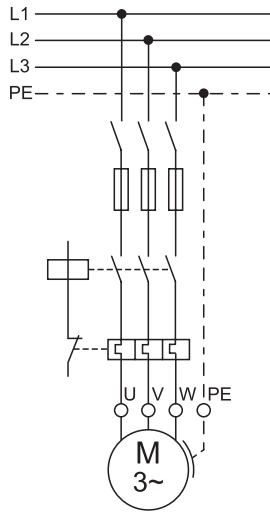

**YΔ**

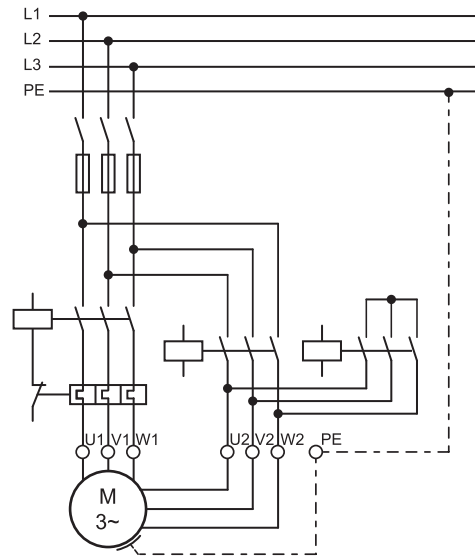

U	V	W	PE
brown	grey	black	yellow/green



# 10" Rewindable Motors

## 10" Rewindable Spare Parts

<b>Kit 1 Thrust Bearing Kit</b>	304/316SS/ 904L	Incl.Pos.: 17; 19; 20; 21; 32; 33	308 750 701
<b>Kit 2 Radial Bearing Kit</b>	304/316SS/ 904L	Incl.Pos.: 15; 34	308 751 701
<b>Kit 3 Seal Kit</b>	304/316SS	Incl.Pos.: 1 - 4; 11; 17; 25	308 800 703
	904L		308 800 704
<b>Kit 4 Up-Thrust Kit</b>	304/316SS/ 904L	Incl.Pos.: 18	308 751 702
<b>Kit 5 Screw Kit</b>	304/316SS	Incl.Pos.: 2.0; 5; 8; 13; 24; 37; 40	308 660 701
	904L		308 660 702
<b>Kit 6 Lead Seal Kit</b>	304/316SS/ 904L	Incl.Pos.: 5; 6; 7	see page 8
<b>Kit 7 PT100 Kit</b>	304/316SS/ 904L	Incl.Pos.: 9	see page 14
<b>Kit 8 Valve Kit</b>	304	Incl.Pos.: 10; 11; 39	308 800 414

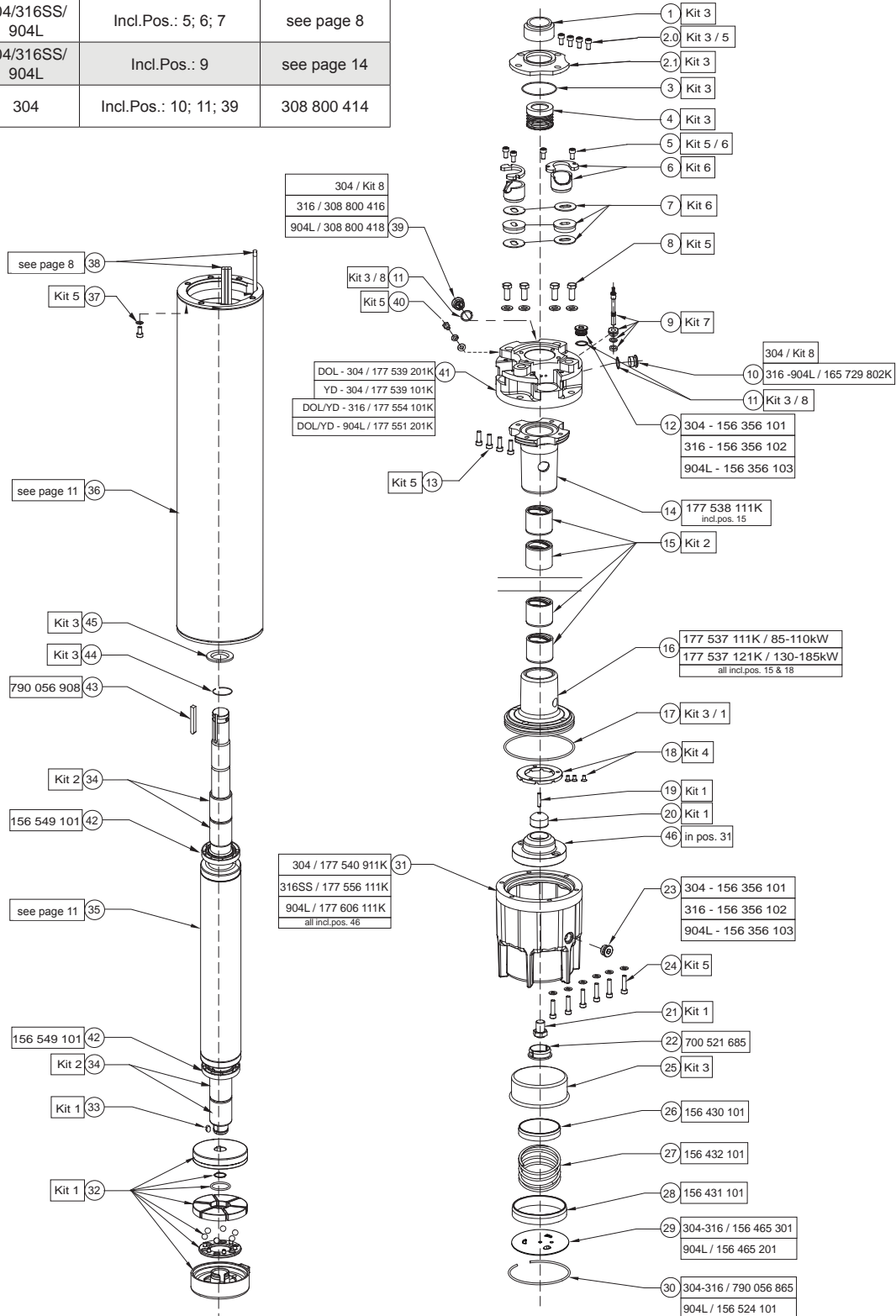



## Stator and Rotor Model Number (50 / 60Hz)

P <sub>N</sub> [kW]	U <sub>N</sub> / f [V] / [Hz]	Stator ( incl. Winding and 6 m motor lead )								Rotor
		304/316		904L		304/316		904L		
		DOL PVC	DOL PE2/PA	DOL PVC	DOL PE2/PA	YΔ PVC	YΔ PE2/PA	YΔ PVC	YΔ PE2/PA	
85	380 - 415/50 460/60	326 150 931	326 292 931	326 150 921	326 292 921	326 150 981	326 292 981	326 150 971	326 292 971	176 379 801K
110	380 - 415/50 460/60	326 158 931	326 302 931	326 158 921	326 302 921	326 158 981	326 302 981	326 158 971	326 302 971	176 379 802K
130	380 - 415/50 460/60	326 168 931	326 314 931	326 168 921	326 314 921	326 168 981	326 314 981	326 168 971	326 314 971	176 379 803K
150	380 - 415/50 460/60					326 177 981	326 325 981	326 177 971	326 325 971	176 379 804K
185	380 - 415/50 460/60					326 360 981	326 448 981	326 360 971	326 448 971	176 379 805K

## PVC Insulation Standard Windings (380 – 415V/50Hz / 460V/60 Hz)

P <sub>N</sub> [kW]	Mod.-No. Windingktis	Turns per coil	Wire diameter [mm]	Type of Isolation	Group connection	Total Wire length [m]	Resistance coil [Ω]	Resistance YΔ (U1-U2) [Ω]	Resistance Dol (U1-V1) [Ω]
85	326 150 999	11+11+11+11	2,5 / 3,6	PVC	Parallel	487,92	0,2825	0,141	0,094
110	326 158 999	8+9+8+9	2,8 / 4,0	PVC	Parallel	426,00	0,1955	0,1080	0,0680
130	326 168 999	7+8+7+8	2,2 / 3,1 2DR.II	PVC	Parallel	849,60	0,1579	0,0789	0,0570
150	326 177 999	6+7+6+7	2,3 / 3,3 2DR.II	PVC	Parallel	809,76	0,1374	0,0730	0,0458
185	326 360 999	5+5+6+5	2,5 / 3,6 2DR.II	PVC	Parallel	736,56	0,1050	0,0570	0,035

## PE2/PA Insulation Standard Windings (380 – 415V/50Hz / 460V/60 Hz)

P <sub>N</sub> [kW]	Mod.-No. Windingktis	Turns per coil	Wire diameter [mm]	Type of Isolation	Group connection	Total Wire length [m]	Resistance coil [Ω]	Resistance YΔ(U1-U2) [Ω]	Resistance Dol (U1-V1) [Ω]
85	326 292 999	11+11+11+11	2,3 / 3,5	PE2/PA	Parallel	488	0,3337	0,1668	0,1112
110	326 302 999	8+9+8+9	2,6 / 3,9	PE2/PA	Parallel	426	0,2267	0,1133	0,0755
130	326 314 999	7+8+7+8	2,0 / 3,1 2DR.II	PE2/PA	Parallel	850	0,1910	0,0955	0,0636
150	326 325 999	6+7+6+7	2,1 / 3,3 2DR.II	PE2/PA	Parallel	810	0,1647	0,0823	0,0549
185	326 448 999	5+5+6+5	2,3 / 3,5 2DR.II	PE2/PA	Parallel	735	0,1240	0,0620	0,0413

## Insulation resistant ( 20°C / 500 VDC)

New motor without drop cable	400 > MΩ
Used motor without drop cable	20 > MΩ
New motor with drop cable	4 > MΩ
Used motor with drop cable	1 MΩ



# 10" Rewindable Motors

## 10" Rewindable Motor Design

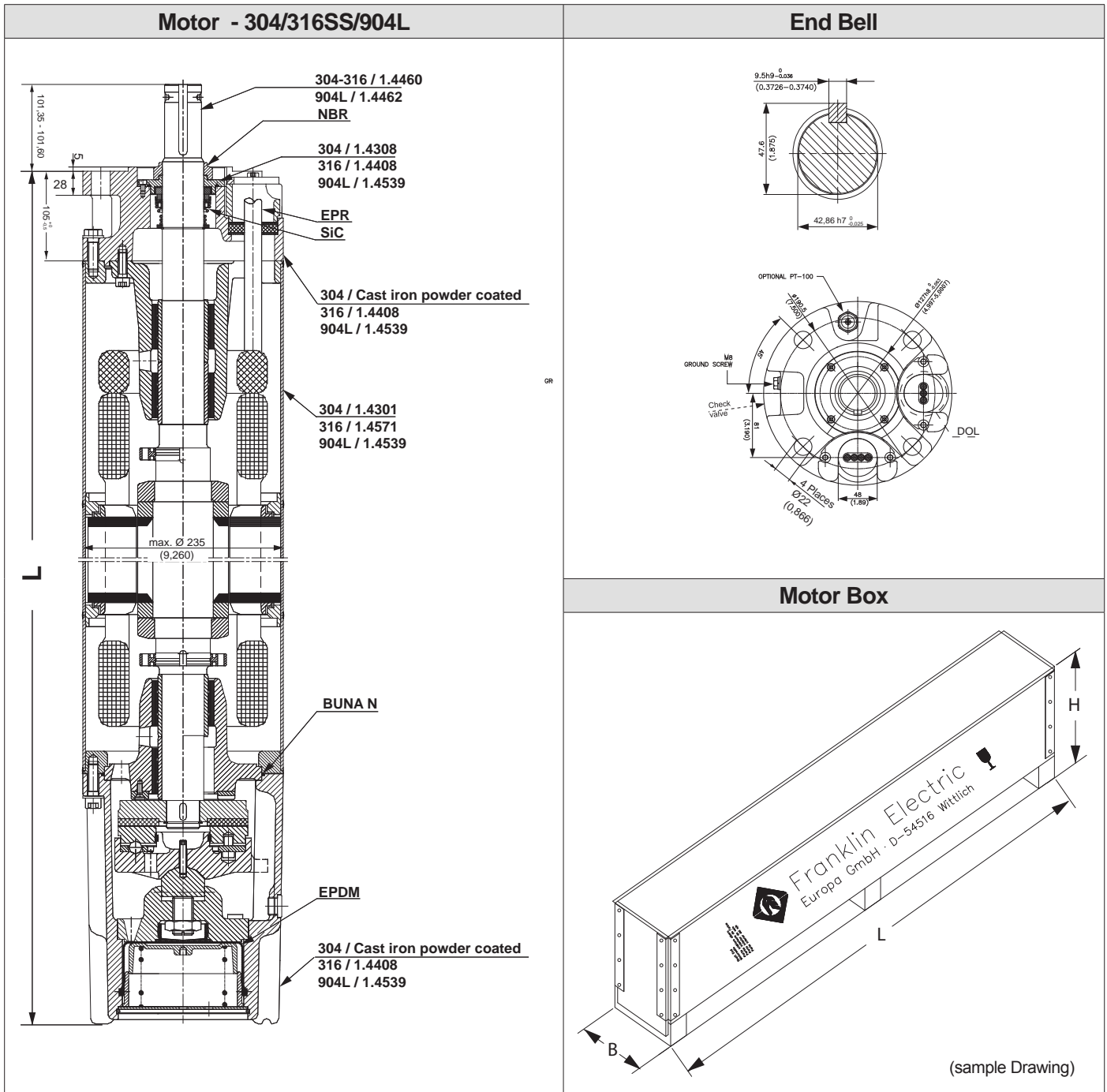

P <sub>N</sub> [kW]	Motor Lengths	Motor Weights [kg]		Motor Shipping Size [mm]		
	L [mm]	Motor	Incl. Pack	B	H	L
85	1419	280	326	341	562	1896
110	1529	315	361			
130	1659	362	412	341	562	2296
150	1769	413	463			
185	1919	449	499			



## Motor Filling Liquid

Filling liquid 5 L FES92



Part number:  
308 353 941

4" Encapsulated	→	FES93	8" Encapsulated Standard	→	FES91
6" Encapsulated Standard	→	FES91	8" Encapsulated HighTemp75	→	FES92
6" Encapsulated High-Temp90	→	FES92	Rewindable Motors All	→	FES93

FES91	FES92	FES93

## Motor Filling Kit

This kit contains all necessary tools to check and replenish Franklin Electric submersible motors with FES 91, 92 or 93 filling liquid (fill solution/concentrate must be ordered separately).

Part number: 308 726 103





# Accessories

## PT100 Rewindable Motors

### Application

- Fitted into the upper end bell flange , all end bells 6" ,8", 10" and 12" Rewindable are prepare for installation PT100
- Measures the temperature of the filling liquid
- Conductor with a resistance proportional to the temperature
- Allows monitoring the temperature continuously

The above-ground equipment is not available from Franklin Electric and is typically part of a custom panel or data acquisition system. PT100 sensor retrofit kits from Franklin Electric come with complete instructions and allow for easy field installation.

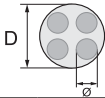

	Ø [mm <sup>2</sup> ]	D [mm]	Lead Lengths [m]		6" Rew Redesign starting 08.2012		6" (Cast Iron/304SS) / 8" / 10" / 12"	
					304/316	904L	304/316	904L
<b>PT 100</b>	4X0,5	8	10	<b>Mod.- No.:</b>	308 016 501	308 016 522	308 016 401	308 016 422
<b>PT 100</b>	4X0,5	8	20	<b>Mod.- No.:</b>	308 016 502	-	308 016 402	-
<b>PT 100</b>	4X0,5	8	30	<b>Mod.- No.:</b>	308 016 503	-	308 016 403	-
<b>PT 100</b>	4X0,5	8	50	<b>Mod.- No.:</b>	308 016 505	308 016 526	308 016 405	308 016 426

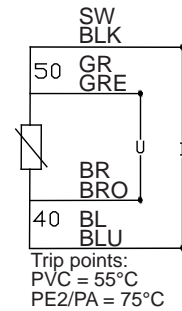

# QUALITY IN THE WELL

POWERED BY



Franklin Electric

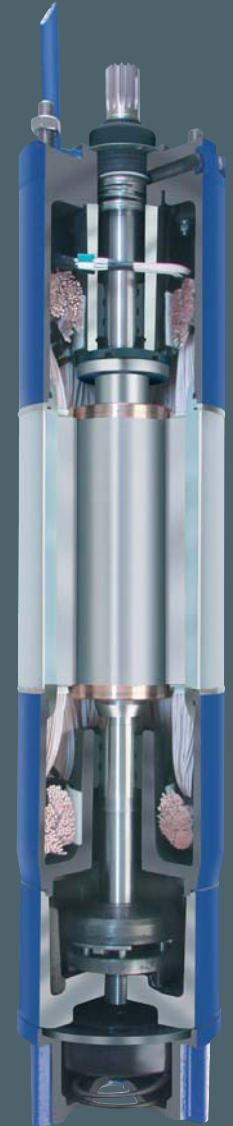
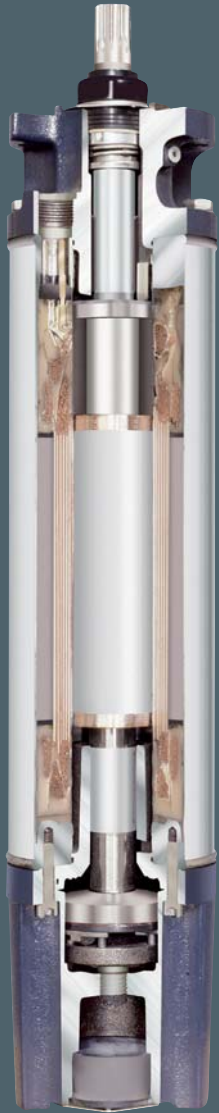

- GB** Franklin Electric is the world largest manufacturer of submersible motors. Our broad product line, quality manufacturing, on time delivery and outstanding service make us the number one choice of pumps manufacturers, distributors and installers worldwide. We invite you to visit our web site at: [www.franklin-electric.eu](http://www.franklin-electric.eu)
- D** Franklin Electric ist der größte Hersteller von Unterwassermotoren weltweit. Unsere weite Produktfamilie, die hohe Qualität der Fertigung, die gute Verfügbarkeit und der außerordentliche Service machen uns zur ersten Wahl für Pumpenhersteller, Händler und Installateure weltweit. Bitte besuchen sie unsere Internet Homepage unter: [www.franklin-electric.eu](http://www.franklin-electric.eu)
- F** Franklin Electric est le plus grand constructeur mondial de moteurs électriques immergés. Notre large gamme de produits, la qualité de nos fabrications, nos délais de livraison courts et notre support client hors du commun, font que nous sommes le choix préférentiel des fabricants de pompes, distributeurs et installateur dans le monde entier. Nous vous invitons à visiter notre site Internet: [www.franklin-electric.eu](http://www.franklin-electric.eu)
- E** Franklin Electric es la mayor fabricante mundial de motores eléctricos sumergibles. Nuestra amplia gama de productos, fabricación de calidad, entregas puntuales y excepcional servicio hace de nosotros la elección número uno entre los fabricantes de bombas, distribuidores e instaladores en todo el mundo. Le invitamos a visitar nuestra página web en: [www.franklin-electric.eu](http://www.franklin-electric.eu)

## Franklin Electric Product Line

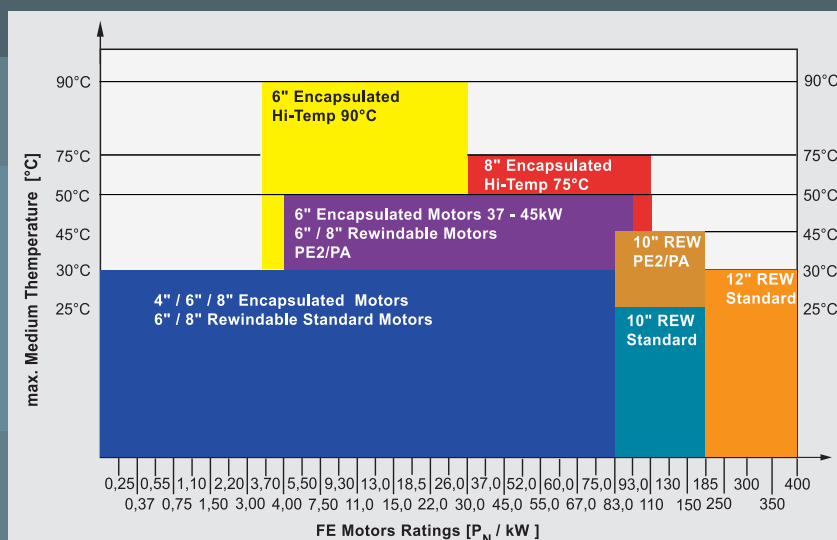



## **Franklin Electric**

Franklin Electric Europa GmbH  
Rudolf-Diesel-Strasse 20  
D-54516 Wittlich/Germany  
Tel.: +49 (0) 6571 / 105-0  
Fax: +49 (0) 6571 / 105-520  
e-mail: [info@franklin-electric.de](mailto:info@franklin-electric.de)  
[www.franklin-electric.eu](http://www.franklin-electric.eu)