

CH



Pompe centrifughe che abbinano medie prevalenze a portate medio alte; adatte per irrigazioni a pioggia e in generale dove oltre alla silenziosità viene richiesta una lieve oscillazione di pressione al variare della portata.

Centrifugal pumps that combine medium head with medium-high delivery; ideal for sprinkle irrigation and in applications where quiet operations are requested and only slight pressure change as the delivery changes.

Bombas centrífugas que combinan prevalencias medias con caudales medio-altos; apropiadas para riegos por aspersión en general donde además del silencio se solicita una leve oscilación de presión cuando varía el caudal.

Pompes centrifuges qui associent des hauteurs manométriques moyennes à des débits moyens-élevés; adaptées pour l'irrigation par aspersion et, en général, quand, en plus du bruit limité, il faut assurer une légère oscillation de pression en fonction de la variation du débit.

CARATTERISTICHE COSTRUTTIVE / CONSTRUCTION FEATURES CARACTERÍSTICAS CONSTRUCTIVAS / CARACTÉRISTIQUES D'EXÉCUTION

Corpo pompa Pump body Cuerpo bomba Corps de pompe	ghisa cast iron fundición fonte
Supporto motore Motor bracket Soporte motor Support moteur	ghisa cast iron fundición fonte
Girante	ottone (CH 160-310) ghisa (CH 350-550)
Impeller	brass (CH 160-310) cast iron (CH 350-550)
Rodete	latón (CH 160-310) fundición (CH 350-550)
Turbine	laiton (CH 160-310) fonte (CH 350-550)
Tenuta meccanica Mechanical seal Sello mecánico Garniture mécanique	ceramica-grafite ceramic-graphite cerámica-grafito céramique-graphite
Albero motore Motor shaft Eje motor Arbre moteur	acciaio AISI 303 stainless steel AISI 303 acero AISI 303 acier AISI 303
Temperatura del liquido Liquid temperature Temperatura del líquido Température du liquide	0 - 90 °C
Pressione di esercizio Operating pressure Presión de trabajo Pression de fonctionnement	max 6 bar
MOTORE / MOTOR / MOTOR / MOTEUR	
Motore 2 poli a induzione	3~ 230/400V-50Hz
2 pole induction motor	1~ 230V-50Hz
Motor de 2 polos a inducción	(con termoprotettore with thermal protection con protección térmica avec protection thermique)
Moteur à induction à 2 pôles	
Classe di isolamento Insulation class Clase de aislamiento Classe d'isolation	F
Grado di protezione Protection degree Grado de protección Protection	IP44

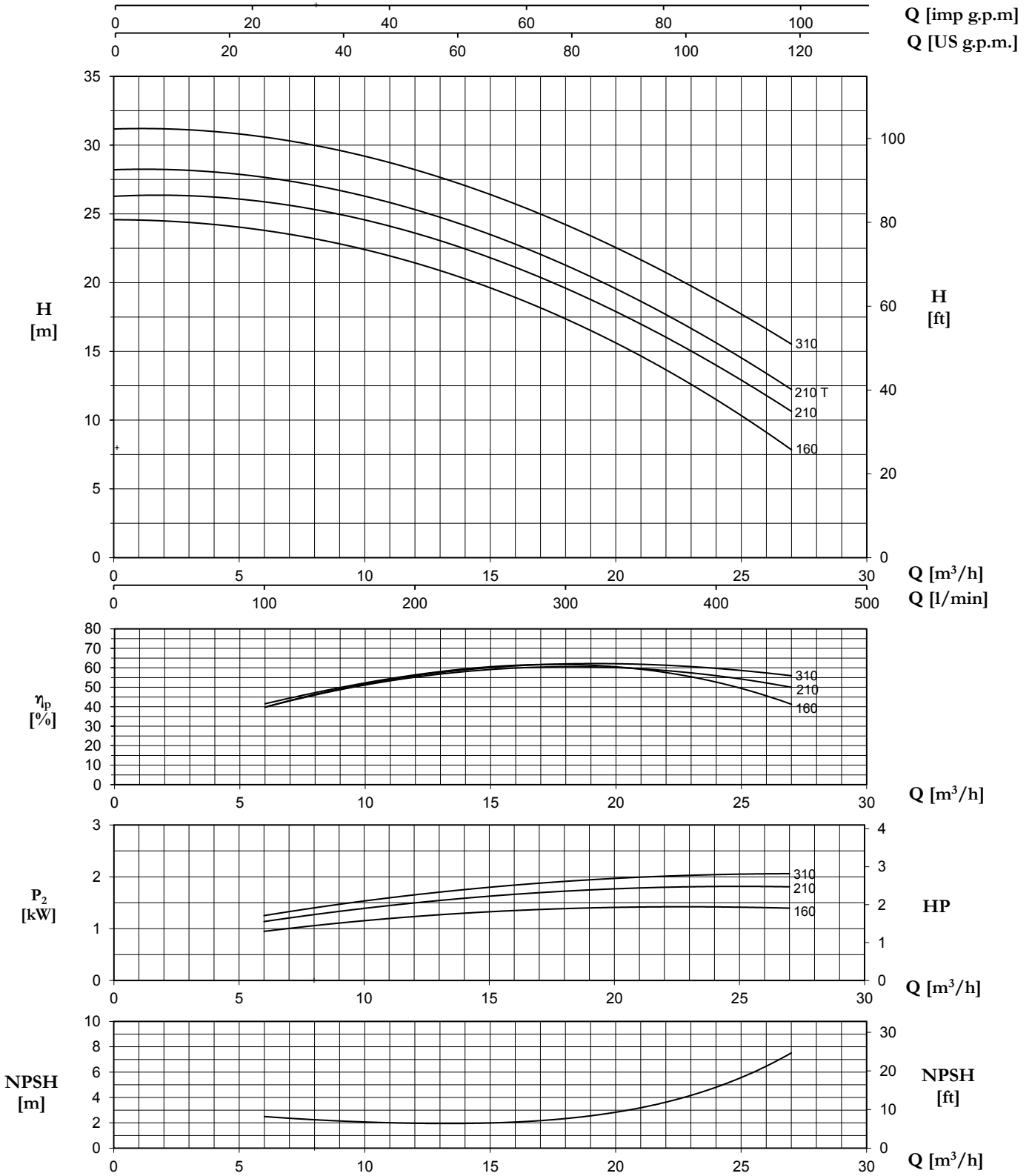

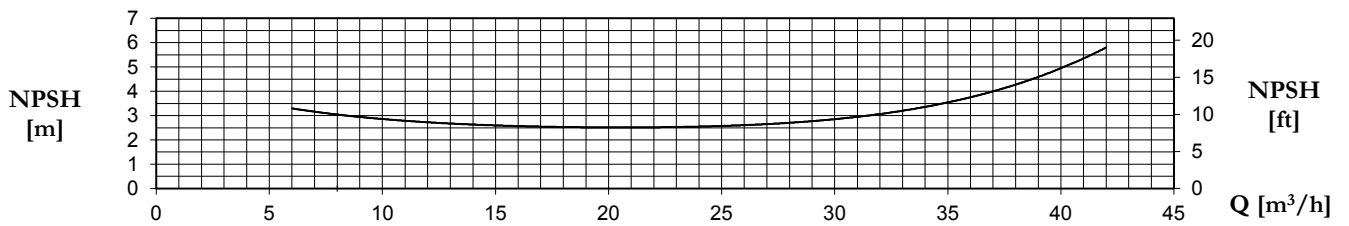
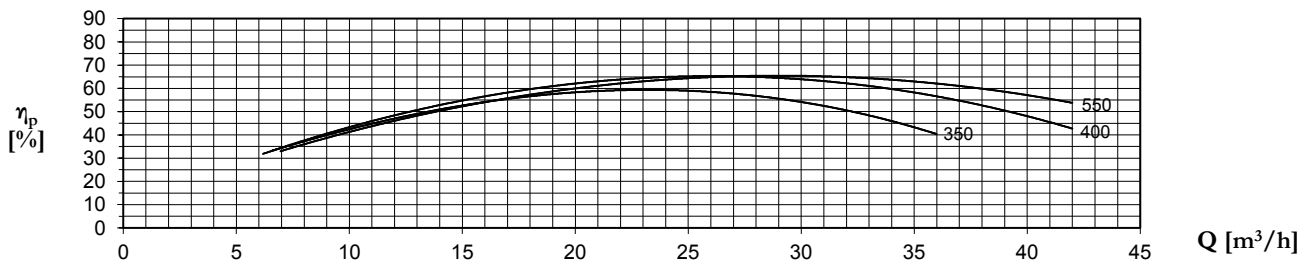
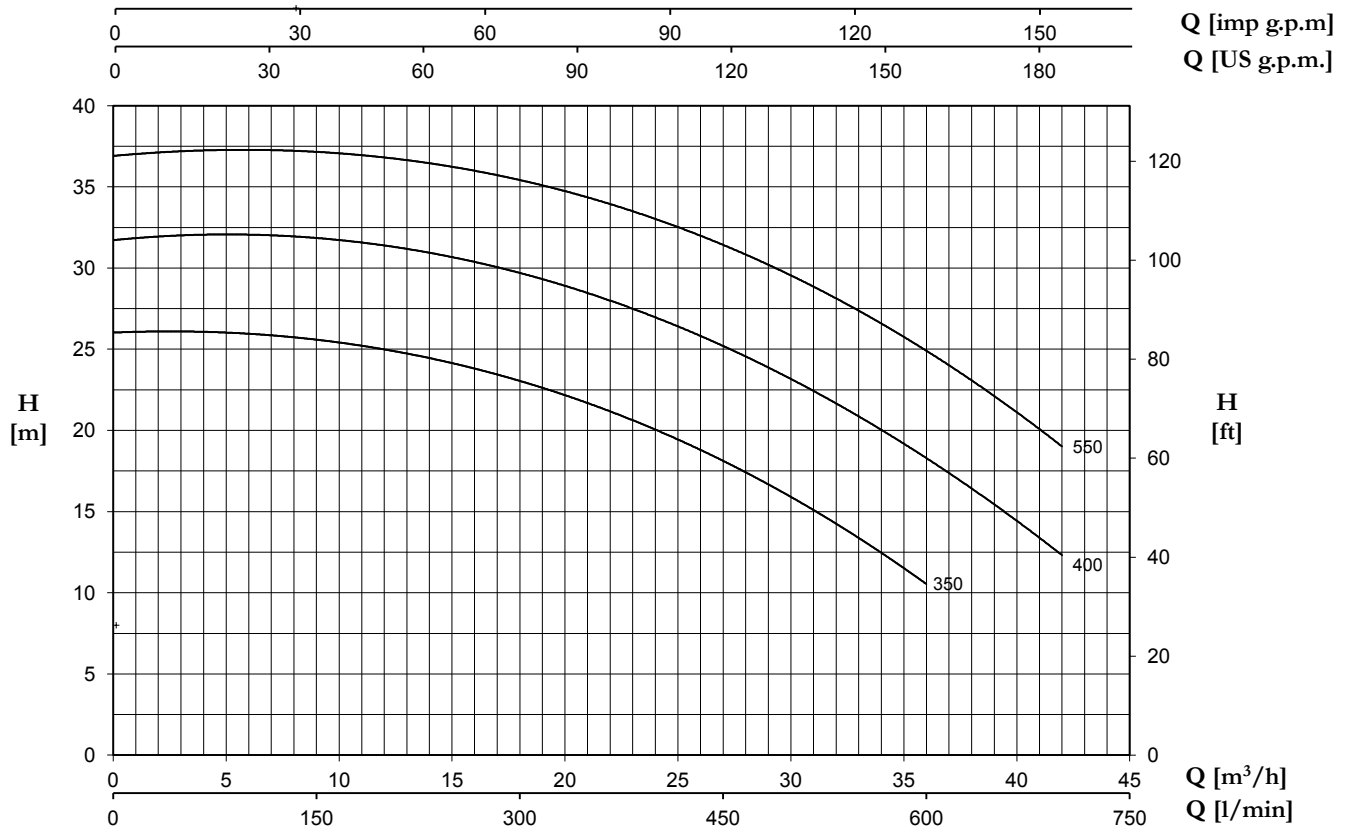

TYPE		P2		P1 (kW)		AMPERE		Q (m³/h - l/min)								
1~	3~					1~	3~	0	6	9	12	15	18	21	24	27
								0	100	150	200	250	300	350	400	450
		(HP)	(kW)	1~	3~	1x230 V 50 Hz	3x400 V 50 Hz	H (m)								
CH 160	CHT 160	1,5	1,1	1,8	1,8	8,3	3,4	24,5	23,9	22,9	21,4	19,5	17,3	14,7	11,6	7,8
CH 210	-	2	1,5	2,1	-	10,1	-	26,3	25,9	25,0	23,6	21,7	19,6	17,1	14,1	10,6
-	CHT 210	2	1,5	-	2,2	-	4,7	28,2	27,6	26,7	25,3	23,5	21,3	18,6	15,6	12,2
CH 310	CHT 310	3	2,2	2,8	2,6	12,4	5,0	31,2	30,5	29,6	28,3	26,4	24,3	21,6	18,6	15,6

CH

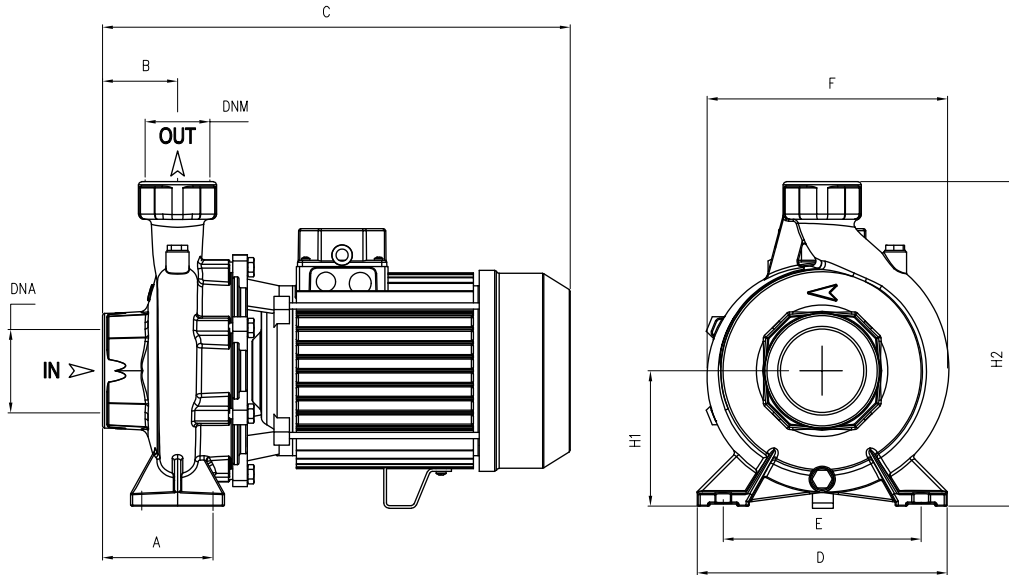

TYPE		P2		P1 (kW)		AMPERE		Q (m³/h - l/min)						
1~	3~	(HP)	(kW)	1~	3~	1~	3~	6	12	18	24	30	36	42
						1x230 V 50 Hz	3x400 V 50 Hz	100	200	300	400	500	600	700
								H (m)						
CH 350	CHT 350	3	2,2	2,95	2,84	13,5	5,1	26	25	23	20	16	10,5	-
CH 400	CHT 400	4	3	4,6	4,2	20,5	7,6	31,8	31,6	29,7	27	23	18,4	12,3
-	CHT 550	5,5	4	-	5,1	-	10	37	37	35,5	33	29,4	25	19



TYPE	DIMENSIONS (mm)														 Kg
	A	B	C	D	E	F	Ø	H1	H2	DNA	DNM	I	L	M	
CH 160	105	48	370	200	160	215	9.5	110	280	2" G	2" G	390	230	300	24,5
CH 210	105	48	370	200	160	215	9.5	110	280	2" G	2" G	390	230	300	26
CH 310	105	48	410	200	160	215	9.5	110	280	2" G	2" G	430	230	300	31,5
CHT 310	105	48	370	200	160	215	9.5	110	280	2" G	2" G	390	230	300	26
CH 350	105	70	425	240	190	240	14	126	306	3" G	2" G	460	270	360	34,5
CHT 350	105	70	385	240	190	240	14	126	306	3" G	2" G	400	270	360	32
CH 400	105	70	445	240	190	240	14	126	306	3" G	2" G	460	270	360	40,5
CHT 400	105	70	425	240	190	240	14	126	306	3" G	2" G	460	270	360	34,5
CHT 550	105	70	445	240	190	240	14	126	306	3" G	2" G	460	270	360	40,5

TYPE				
	TRUCK		CONTAINER	
	PALLET (cm)	N° pumps	PALLET (cm)	N° pumps
CH 160-310	85x11x140	40	85x110x195	60
CH 350-550	85x110x150	30	85x110x180	30