

4SR

Electrobombas sumergidas de 4"

 Agua limpia
(Contenido de arena
máximo 150 g/m³)

 Utilizo doméstico

 Utilizo civil

 Utilizo industrial



CAMPO DE PRESTACIONES

- Caudal hasta **340 l/min** (20.4 m³/h)
- Altura manométrica hasta **405 m**

LIMITES DE UTILIZO

- Temperatura máxima del fluido hasta **+35 °C**
- Contenido de arena máximo **150 g/m³**
- Profundidad de utilizo hasta **100 m** bajo el nivel del agua
- Funcionamiento:
 - en vertical
 - en horizontal con los siguientes límites:
 - 4SR1 - 4SR1.5 - 4SR2 - 4SR4 hasta **27 etapas**
 - 4SR6 - 4SR8 hasta **17 etapas**
 - 4SR10 - 4SR12 - 4SR15 hasta **12 etapas**
- Arranques/hora: **20** a intervalos regulares
- Flujo de enfriamiento motor mínimo **8 cm/s**
- Funcionamiento continuo **S1**

EJECUCION Y NORMAS DE SEGURIDAD

MOTOR ELECTRICO

- Monofásica 220-230 V - 50 Hz
- Trifásica 400 V - 50 Hz

Cable de alimentación de:

- **2 m** para potencias de 0.37 a 2.2 kW
- **3.6 m** para potencias de 3 a 7.5 kW.

EN 60335-1
IEC 60335-1
CEI 61-150

EN 60034-1
IEC 60034-1
CEI 2-3



REGLAMENTO (UE) N. 547/2012

CERTIFICACIONES

Empresa con sistema de gestión certificado DNV
ISO 9001: CALIDAD
ISO 14001: AMBIENTE



UTILIZOS E INSTALACIONES

Se aconsejan para bombear agua limpia con contenido de arena no superior a **150 g/m³**. Debido al alto rendimiento y fiabilidad, son aptas para usos en el campo doméstico, civil e industrial, para la distribución del agua en acoplamiento con autoclaves, riegos, instalaciones de lavado, aumento de presión para instalaciones anti-incendio, etc.

PATENTES - MARCAS - MODELOS

- Patente n° EP2419642

EJECUCION BAJO PEDIDO

- Otros voltajes o frecuencia 60 Hz
- **Kit camisa de enfriamiento completo con filtro y soportes**



GARANTIA

2 años según nuestras condiciones generales de venta

CAMPO DE PRESTACIONES

50 Hz n = 2900 rpm

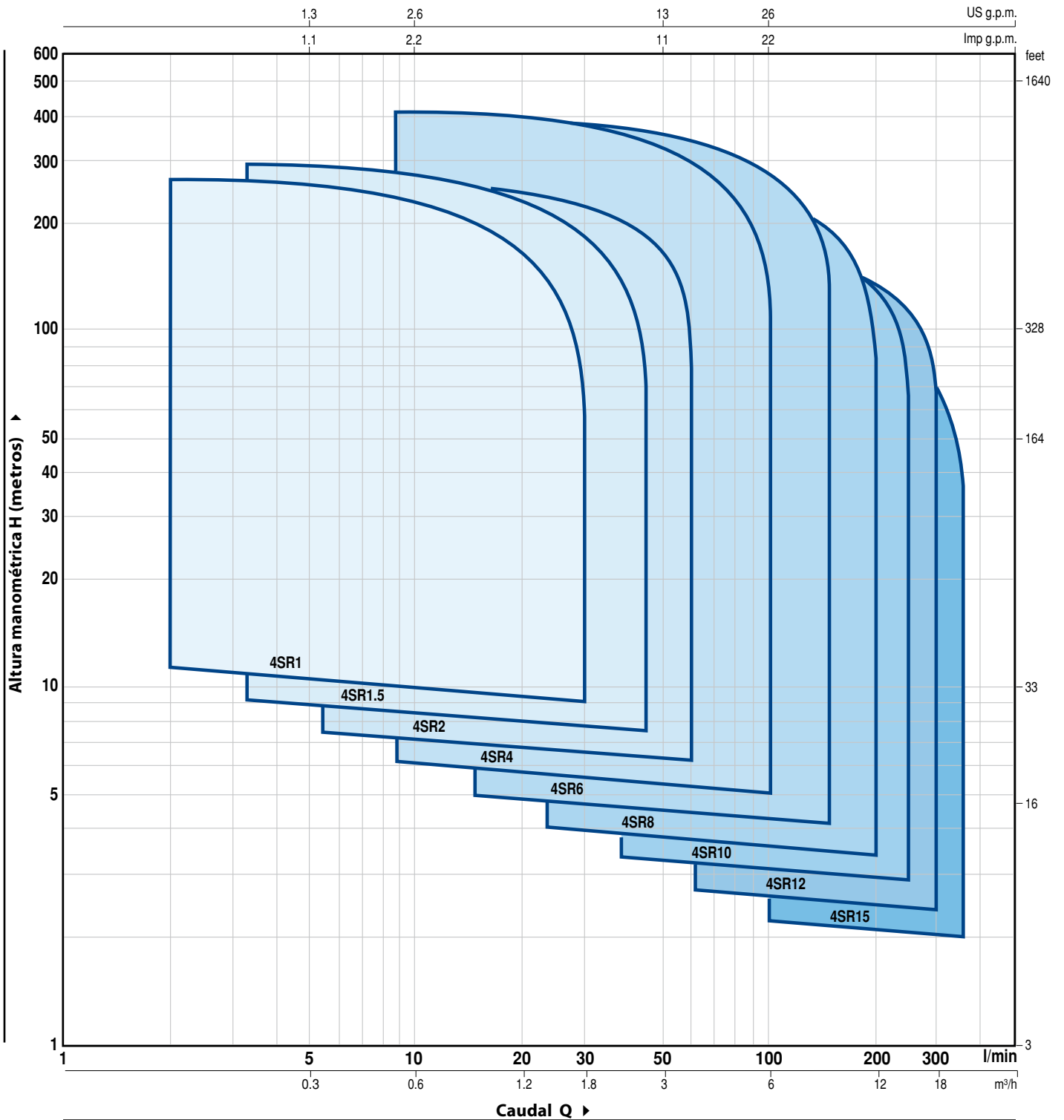

NOMENCLATURA

4 SR 1 m / 13 - PD o PS o HYD

- Diámetro del pozo en pulgadas _____
- Serie _____
- Caudal en m³/h en el punto de máximo rendimiento _____
- Motor monofásico _____
- Número de etapas _____
- PD:** electrobomba con motor 4PD "PEDROLLO" _____
- PS:** electrobomba con motor 4PS "PEDROLLO" _____
- HYD:** bomba sin motor _____

4SR1

CURVAS Y DATOS DE PRESTACIONES

50 Hz n= 2900 rpm

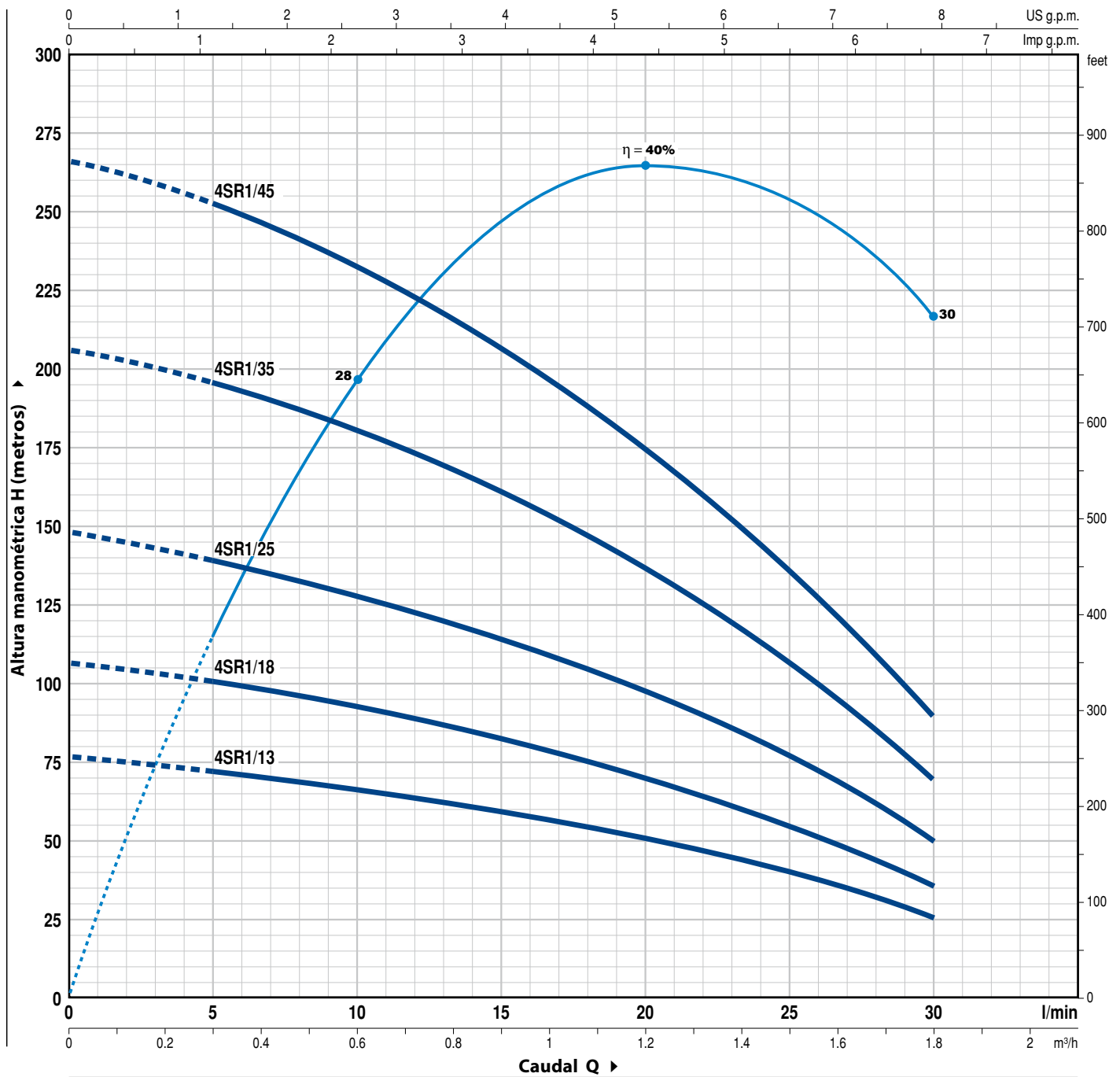

MODELO		POTENCIA (P ₂)		Q	0	0.3	0.6	0.9	1.2	1.5	1.8
Monofásica	Trifásica	kW	HP		0	5	10	15	20	25	30
4SR1m/13	4SR1/13	0.37	0.50	H metros	77	73	67	60	51	40	26
4SR1m/18	4SR1/18	0.55	0.75		107	101	93	83	71	55	36
4SR1m/25	4SR1/25	0.75	1		148	140	129	115	98	77	50
4SR1m/35	4SR1/35	1.1	1.5		206	197	182	161	136	107	70
4SR1m/45	4SR1/45	1.5	2		266	254	234	207	176	137	90

Q = Caudal H = Altura manométrica total

Tolerancia de las curvas de prestación según EN ISO9906 Grado 3B.

CURVAS Y DATOS DE PRESTACIONES

50 Hz n = 2900 rpm

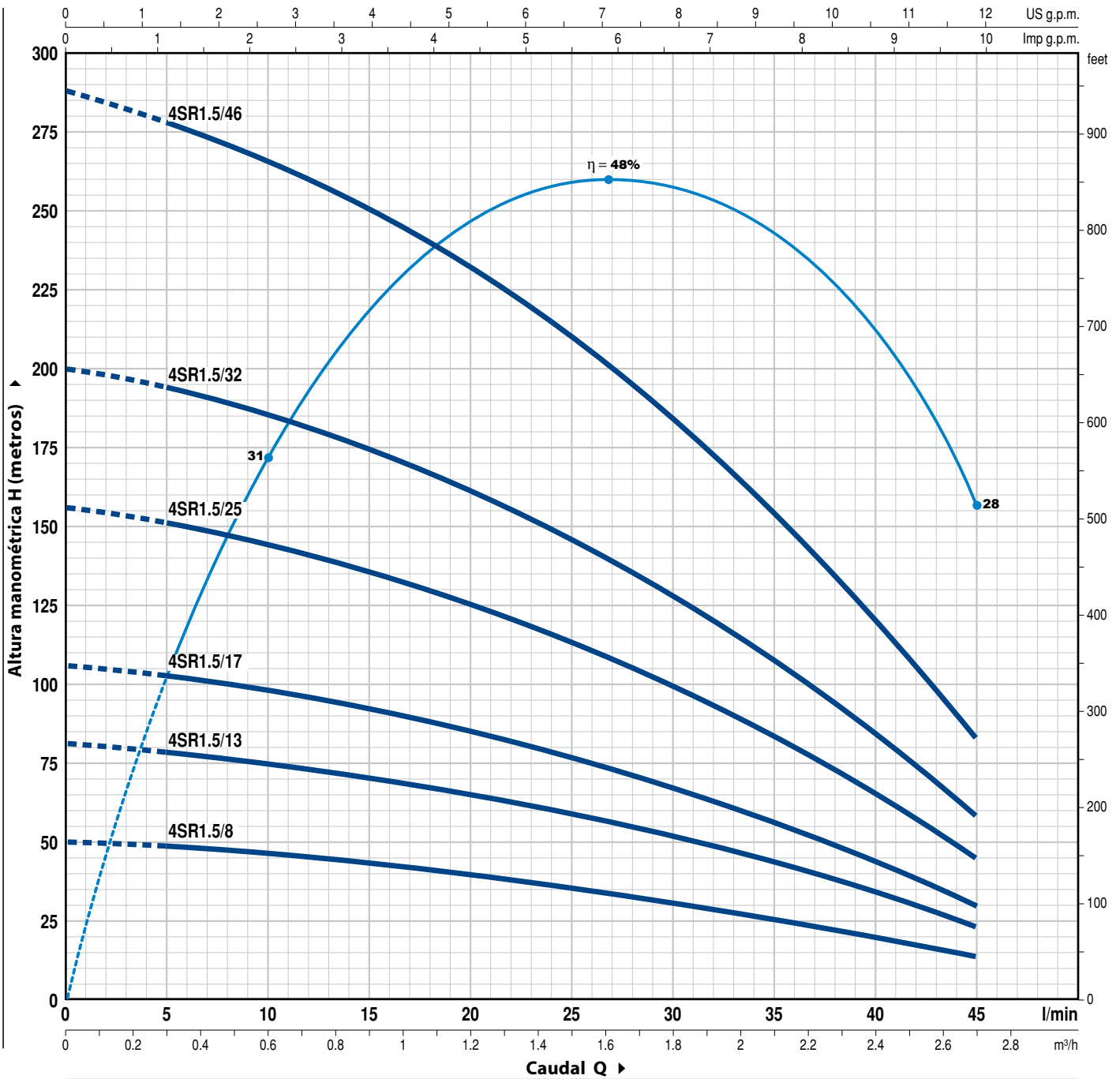

MODELO		POTENCIA (P ₂)		Q	H metros												
Monofásica	Trifásica	kW	HP		0	0.3	0.6	0.9	1.2	1.5	1.8	2.1	2.4	2.7			
				l/min	0	5	10	15	20	25	30	35	40	45			
4SR1.5m/8	4SR1.5/8	0.37	0.50	H metros	50	48	46	44	40	36	32	26	20	14			
4SR1.5m/13	4SR1.5/13	0.55	0.75		81	78	75	71	66	59	52	43	33	23			
4SR1.5m/17	4SR1.5/17	0.75	1		106	102	98	93	86	78	68	56	43	30			
4SR1.5m/25	4SR1.5/25	1.1	1.5		156	151	144	136	127	115	100	83	64	45			
4SR1.5m/32	4SR1.5/32	1.5	2		200	193	184	175	162	147	128	106	82	58			
4SR1.5m/46	4SR1.5/46	2.2	3		288	277	265	250	233	211	184	153	117	83			

Q = Caudal H = Altura manométrica total

Tolerancia de las curvas de prestación según EN ISO9906 Grado 3B.

4SR2

CURVAS Y DATOS DE PRESTACIONES

50 Hz n= 2900 rpm

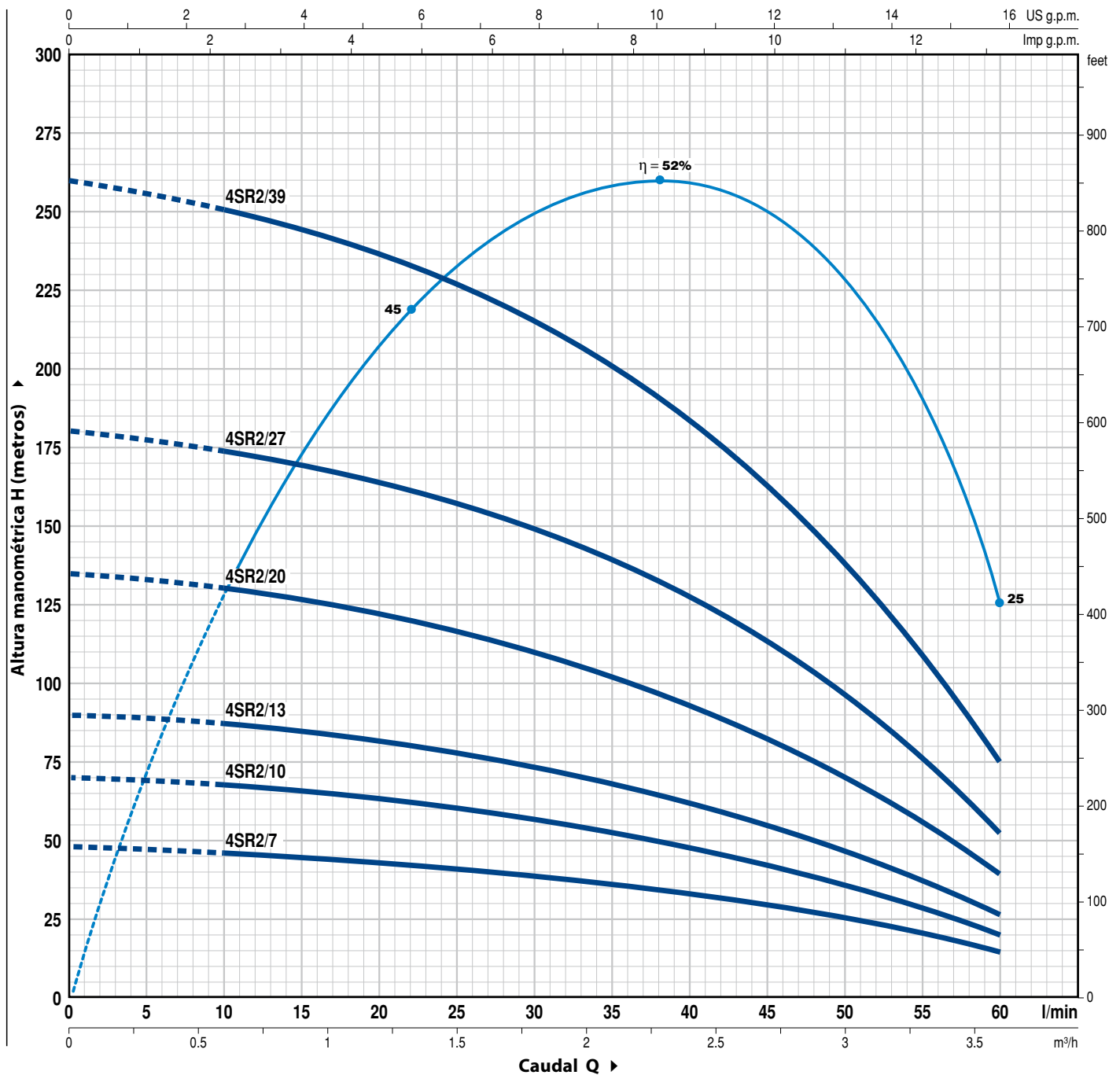

MODELO		POTENCIA (P ₂)		Q	0	0.6	1.2	1.8	2.4	3.0	3.6
Monofásica	Trifásica	kW	HP								
4SR2m/7	4SR2/7	0.37	0.50	H metros	0	10	20	30	40	50	60
4SR2m/10	4SR2/10	0.55	0.75		48	46	44	39	33	25	14
4SR2m/13	4SR2/13	0.75	1		70	68	63	57	48	36	20
4SR2m/20	4SR2/20	1.1	1.5		90	88	82	74	62	46	26
4SR2m/27	4SR2/27	1.5	2		135	130	122	111	93	71	39
4SR2m/39	4SR2/39	2.2	3		180	173	164	150	126	96	52
					260	250	238	216	183	138	75

Q = Caudal H = Altura manométrica total

Tolerancia de las curvas de prestación según EN ISO9906 Grado 3B.

CURVAS Y DATOS DE PRESTACIONES

50 Hz n = 2900 rpm

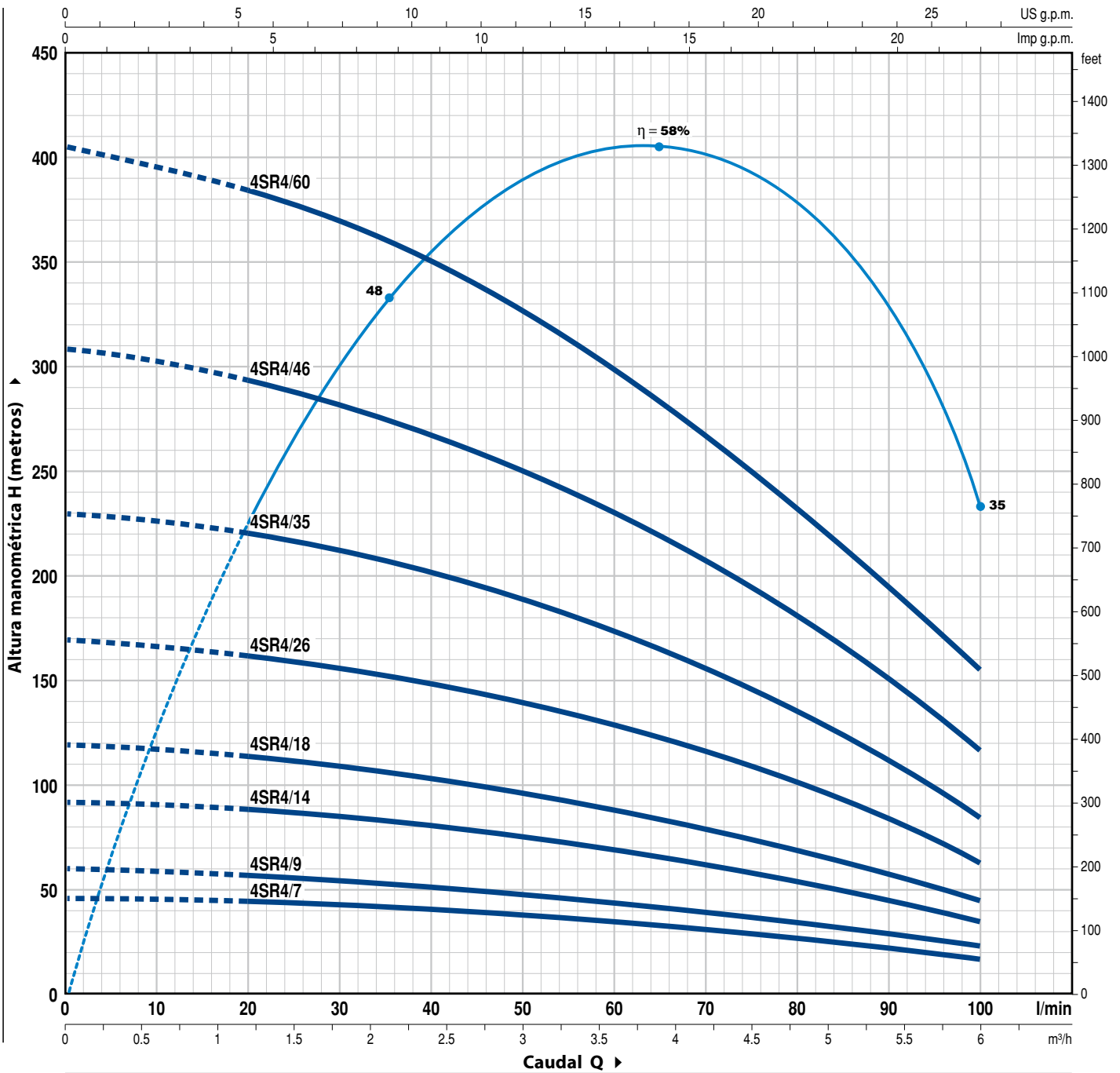

MODELO		POTENCIA (P ₂)		Q	Caudal (l/min)													
Monofásica	Trifásica	kW	HP		0	1.2	1.8	2.4	3.0	3.6	4.2	4.8	5.4	6.0				
4SR4m/7	4SR4/7	0.55	0.75	H metros	46	44	42	40	38	35	32	28	23	17				
4SR4m/9	4SR4/9	0.75	1		60	56	55	52	49	45	40	35	29	23				
4SR4m/14	4SR4/14	1.1	1.5		92	88	85	81	76	70	63	55	45	35				
4SR4m/18	4SR4/18	1.5	2		120	112	109	104	98	90	81	70	58	45				
4SR4m/26	4SR4/26	2.2	3		170	162	157	150	141	130	116	101	84	63				
-	4SR4/35	3	4		230	220	211	202	190	175	157	137	113	85				
-	4SR4/46	4	5.5		308	293	280	269	249	230	205	181	151	117				
-	4SR4/60	5.5	7.5		405	385	370	350	325	300	270	235	195	155				

Q = Caudal H = Altura manométrica total

Tolerancia de las curvas de prestación según EN ISO9906 Grado 3B.

4SR6

CURVAS Y DATOS DE PRESTACIONES

50 Hz n = 2900 rpm

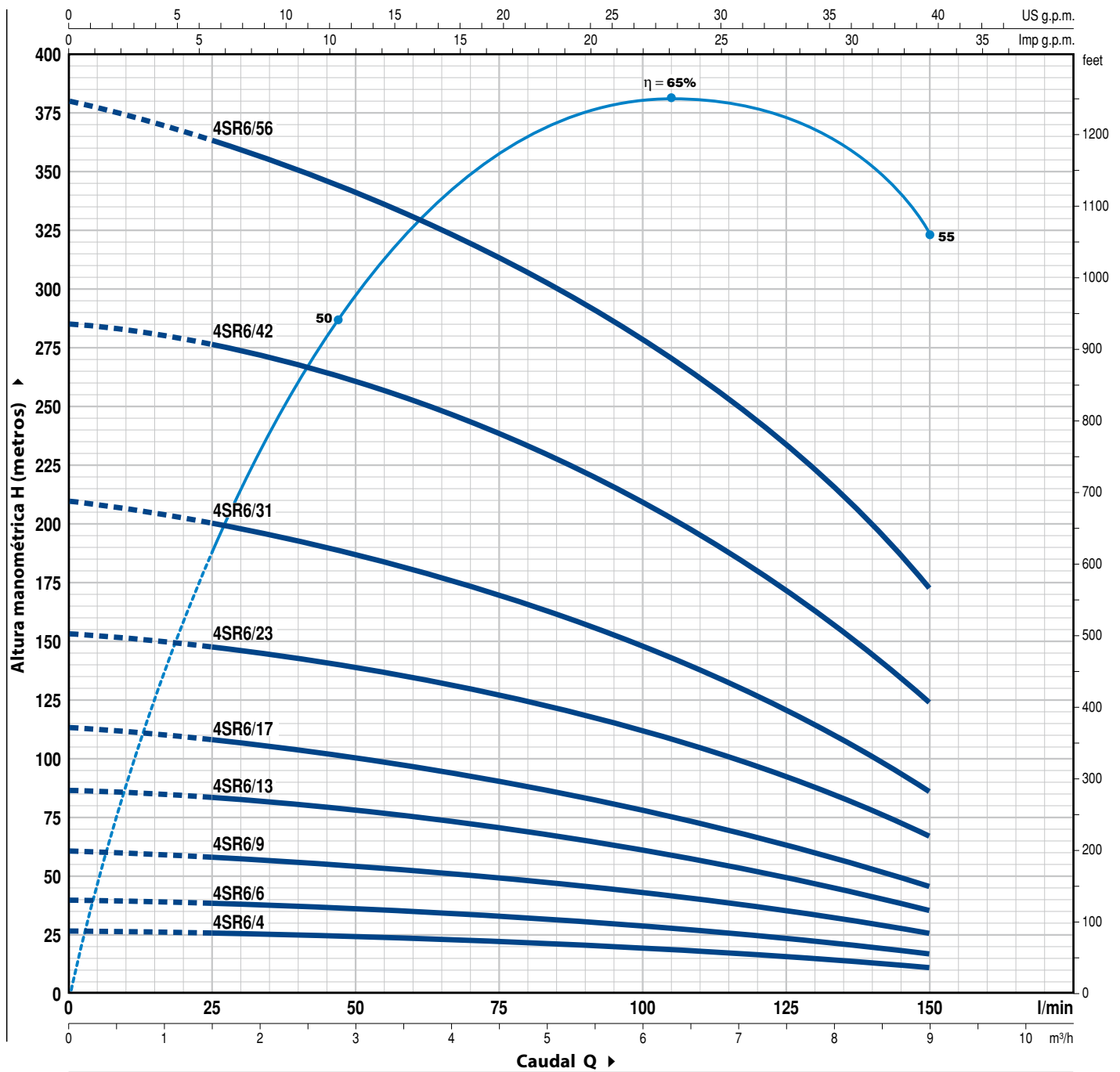

MODELO		POTENCIA (P ₂)		Q	m ³ /h	0	1.5	3.0	4.5	6.0	7.5	9.0
Monofásica	Trifásica	kW	HP									
4SR6m/4	4SR6/4	0.55	0.75	H metros	0	27	26	24	22	19	15	11
4SR6m/6	4SR6/6	0.75	1		40	38	36	33	29	24	17	
4SR6m/9	4SR6/9	1.1	1.5		61	58	54	50	44	35	26	
4SR6m/13	4SR6/13	1.5	2		87	83	78	71	61	49	35	
4SR6m/17	4SR6/17	2.2	3		114	107	100	91	79	62	45	
-	4SR6/23	3	4		154	148	138	128	112	92	67	
-	4SR6/31	4	5.5		210	200	186	170	149	121	86	
-	4SR6/42	5.5	7.5		285	276	258	240	212	170	124	
-	4SR6/56	7.5	10		380	365	340	315	280	233	173	

Q = Caudal H = Altura manométrica total

Tolerancia de las curvas de prestación según EN ISO9906 Grado 3B.

CURVAS Y DATOS DE PRESTACIONES

50 Hz n= 2900 rpm

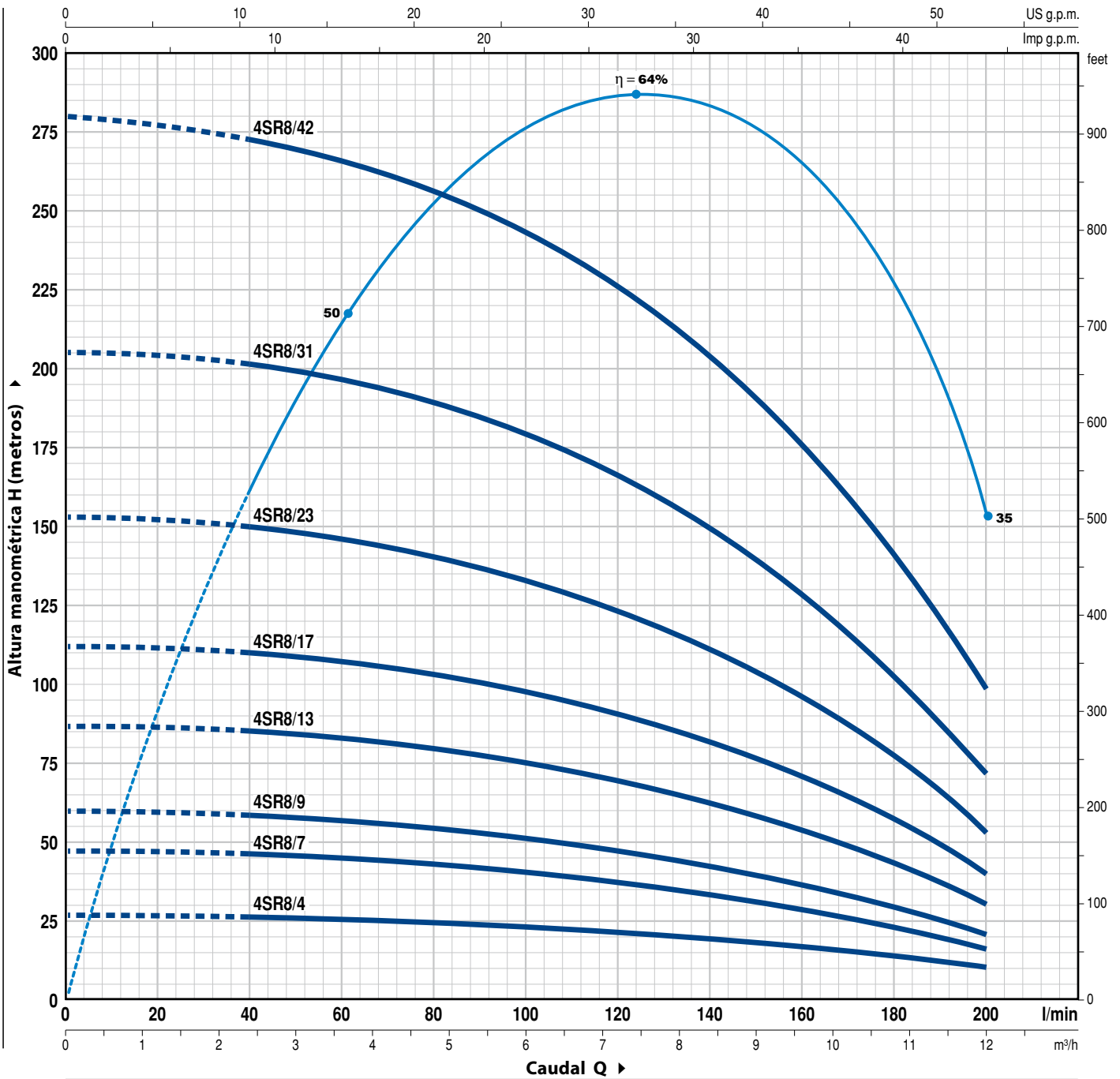

MODELO		POTENCIA (P ₂)		Q	H metros													
Monofásica	Trifásica	kW	HP		0	2.4	3.6	4.8	6.0	7.2	8.4	9.6	10.8	12.0				
				l/min	0	40	60	80	100	120	140	160	180	200				
4SR8m/4	4SR8/4	0.75	1	H metros	27	26	25	24	23	22	20	17	13	10				
4SR8m/7	4SR8/7	1.1	1.5		47	46	45	43	41	38	34	29	23	16				
4SR8m/9	4SR8/9	1.5	2		60	58	57	55	52	48	43	37	30	21				
4SR8m/13	4SR8/13	2.2	3		87	85	83	80	76	70	63	54	43	30				
-	4SR8/17	3	4		112	110	108	104	99	92	82	70	56	40				
-	4SR8/23	4	5.5		153	150	146	141	134	124	111	95	76	53				
-	4SR8/31	5.5	7.5		205	200	196	190	181	167	149	128	103	72				
-	4SR8/42	7.5	10		280	272	266	257	244	225	202	175	140	98				

Q = Caudal H = Altura manométrica total

Tolerancia de las curvas de prestación según EN ISO9906 Grado 3B.

4SR10

CURVAS Y DATOS DE PRESTACIONES

50 Hz n = 2900 rpm

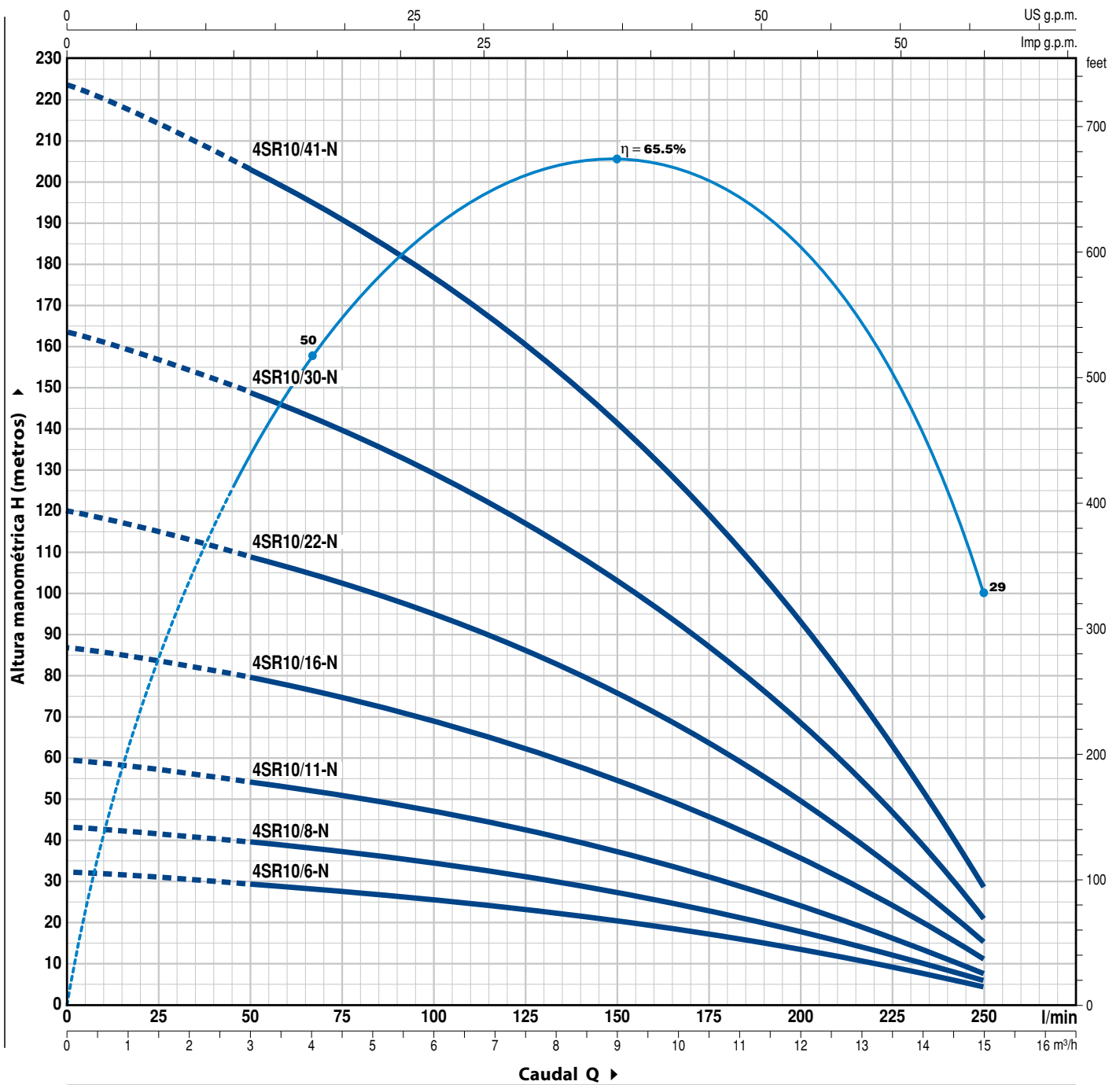

MODELO		POTENCIA (P ₂)		Q	H metros									
Monofásica	Trifásica	kW	HP		0	3.0	6.0	7.5	9.0	10.5	12	13.5	15.0	
				l/min	0	50	100	125	150	175	200	225	250	
4SR10m/6 -N	4SR10/6 -N	0.75	1	H metros	33	29	25	23	20.5	17	13.5	9	4	
4SR10m/8 -N	4SR10/8 -N	1.1	1.5		43	39	35	31	27.5	23	18	12	6	
4SR10m/11 -N	4SR10/11 -N	1.5	2		60	54	47	42	37.5	31	25	16.5	8	
4SR10m/16 -N	4SR10/16 -N	2.2	3		87	79	69	62	55	45	36.5	24	11	
-	4SR10/22 -N	3	4		120	109	95	85	76	63	50	33	15	
-	4SR10/30 -N	4	5.5		163	148	129	116	103	86	68	45	21	
-	4SR10/41 -N	5.5	7.5		223	203	176	159	141	117	93	61.5	29	

Q = Caudal H = Altura manométrica total

Tolerancia de las curvas de prestación según EN ISO9906 Grado 3B.

CURVAS Y DATOS DE PRESTACIONES

50 Hz n= 2900 rpm

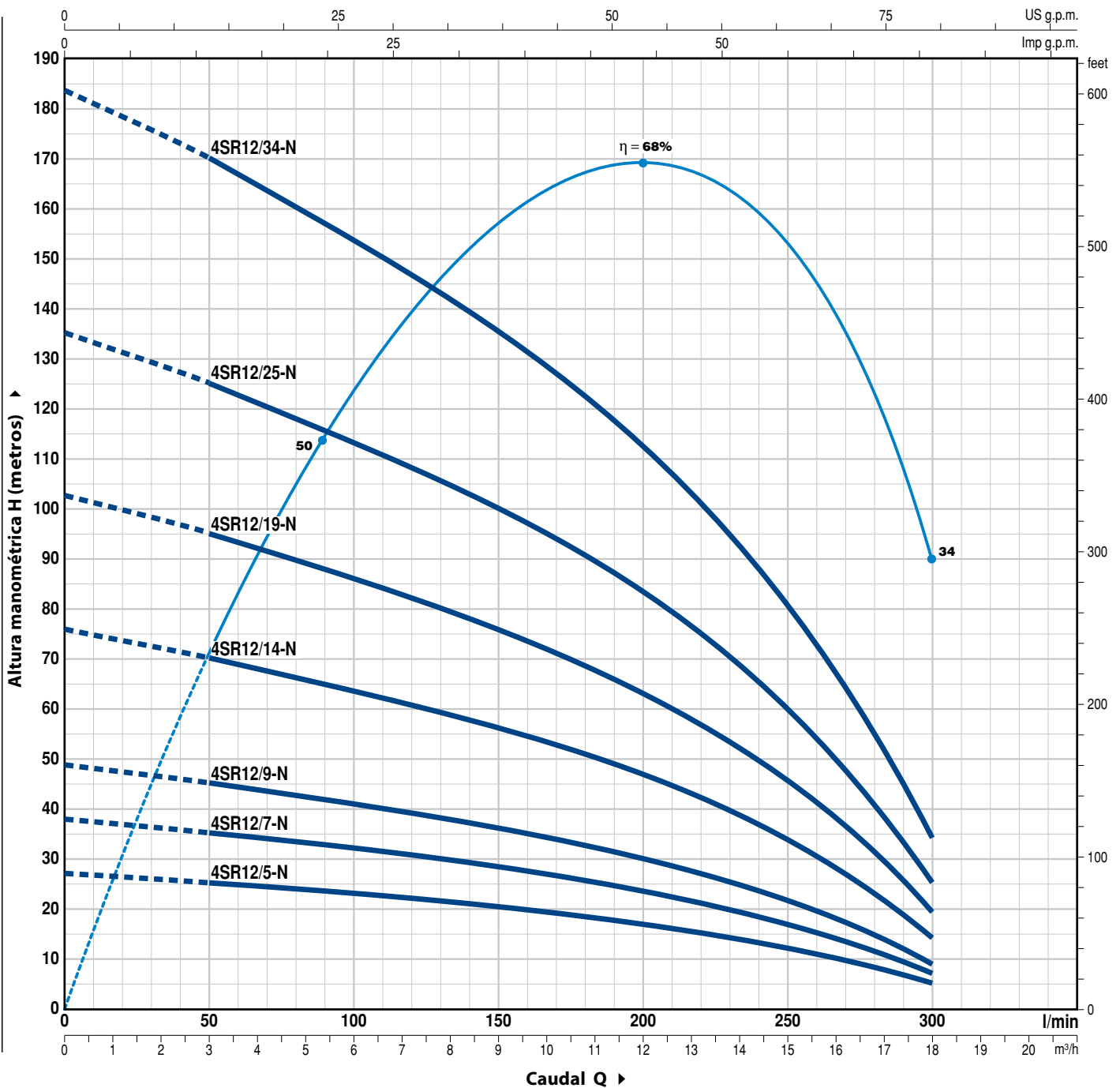

MODELO		POTENCIA (P ₂)		Q	Caudal (l/min)													
Monofásica	Trifásica	kW	HP		0	3.0	6.0	8.4	10.2	12	13.8	15.6	16.8	18.0				
4SR12m/5 -N	4SR12/5 -N	0.75	1	H metros	27	25	22.5	20.5	18.5	16.5	14	10.7	8	5				
4SR12m/7 -N	4SR12/7 -N	1.1	1.5		38	35	31.5	28.5	26	23.2	19.7	15	11.2	7				
4SR12m/9 -N	4SR12/9 -N	1.5	2		48	45	40.7	36.7	33.5	29.8	25.4	19.2	14.5	9				
4SR12m/14 -N	4SR12/14 -N	2.2	3		75	70	63.3	57	52	46.5	39.5	30	22.5	14				
-	4SR12/19 -N	3	4		102	95	85.8	77.5	70.7	63	53.5	40.5	30.5	19				
-	4SR12/25 -N	4	5.5		135	125	113	102	93	83	70.5	53.5	40.2	25				
-	4SR12/34 -N	5.5	7.5		183	170	153.7	138.7	126.5	112.8	95.8	72.7	54.7	34				

Q = Caudal H = Altura manométrica total

Tolerancia de las curvas de prestación según EN ISO9906 Grado 3B.

4SR15

CURVAS Y DATOS DE PRESTACIONES

50 Hz n= 2900 rpm

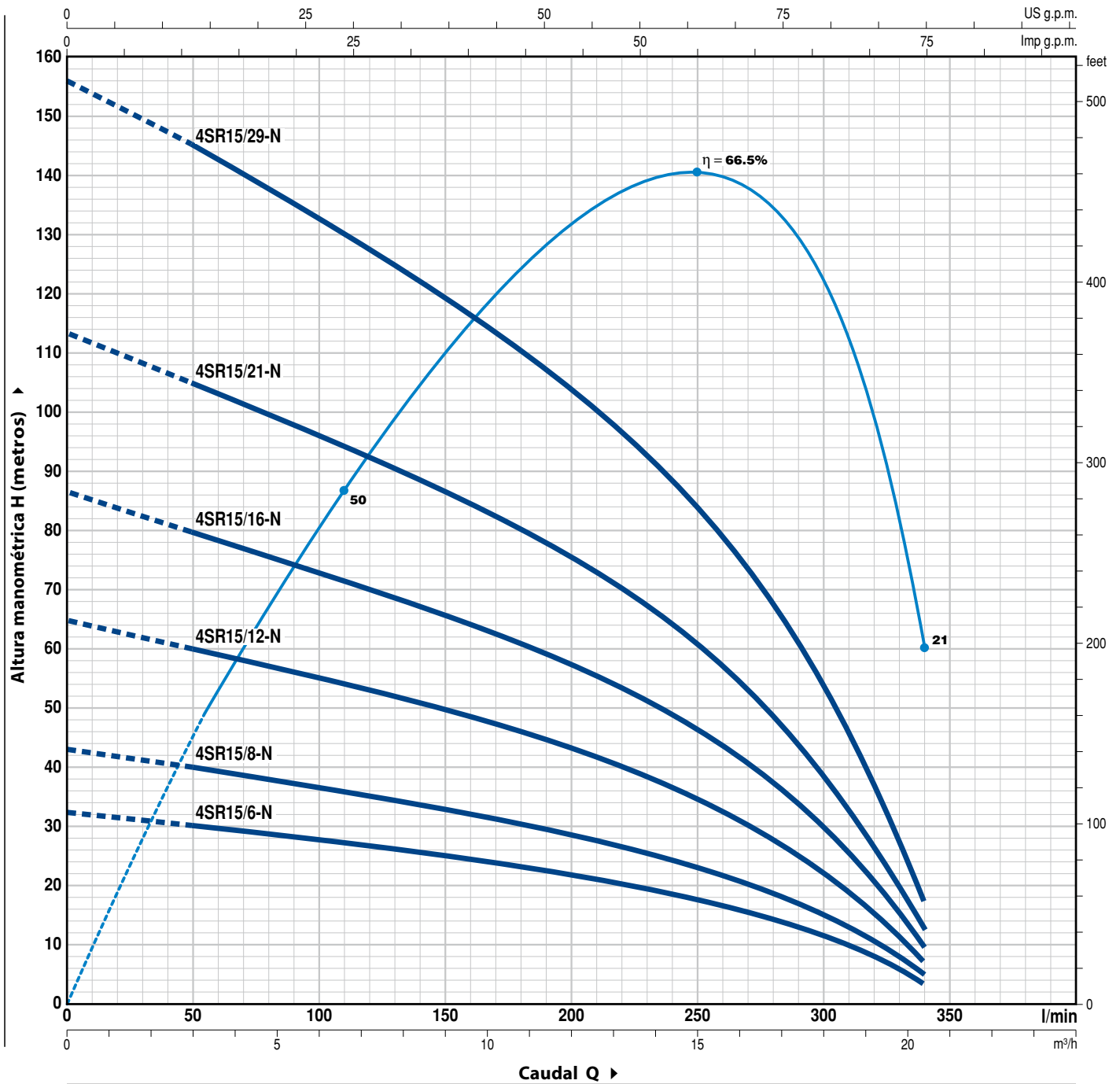

MODELO		POTENCIA (P ₂)		Q	Flow Rate (m³/h)									
Monofásica	Trifásica	kW	HP		0	3.0	6.0	9.0	12	15	18	19.2	20.4	
4SR15m/6 -N	4SR15/6 -N	1.1	1.5	0	0	50	100	150	200	250	300	320	340	
4SR15m/8 -N	4SR15/8 -N	1.5	2	H metros	32	30	27.5	24.5	21.5	17.5	11	7.5	3	
4SR15m/12 -N	4SR15/12 -N	2.2	3		43	40	36.5	32.5	28.5	23.5	14.5	10	5	
-	4SR15/16 -N	3	4		64	60	54.5	49	43	35	22	15	7	
-	4SR15/21 -N	4	5.5		86	80	73	65.5	57.5	46.5	29.5	20.5	9	
-	4SR15/29 -N	5.5	7.5		113	105	95.5	86	75.5	61	38.5	26.5	12	
					156	145	132	119	104.5	84.5	53	37	17	

Q = Caudal H = Altura manométrica total

Tolerancia de las curvas de prestación según EN ISO9906 Grado 3B.

POS. COMPONENTE

CARACTERISTICAS CONSTRUCTIVAS

1 CUERPO DE IMPULSION	Acero inoxidable micro fundido AISI 304 dotado de boca de impulsión roscada ISO 228/1
2 VALVULA DE RETENCION	Acero inoxidable AISI 304
3 SOPORTE	Acero inoxidable AISI 304, dimensiones según norma NEMA
4 RODETE	Lexan 141-R para 4SR1-1.5-2-4-6-8 Noryl FE1520PW para 4SR10-12-15
5 DIFUSOR	Noryl FE1520PW
6 CAJA PORTA DIFUSOR	Acero inoxidable AISI 304
7 EJE BOMBA	Acero inoxidable AISI 304
8 RODAMIENTOS BOMBA	Parte fija en tecnopolímero especial y parte rotatoria en acero inoxidable AISI 316 revestida de óxido de cromo para resistir a la arena
9 CASQUILLO	Acero inoxidable AISI 316L hasta 2.2 kW; Acero inoxidable AISI 304 para potencias superiores
10 FILTRO	Acero inoxidable AISI 304
11 PROTECTOR CABLE	Acero inoxidable AISI 304
12 MOTOR 4"	4PD = motor en baño de aceite "PEDROLLO" 4PS = motor en baño de agua "PEDROLLO"

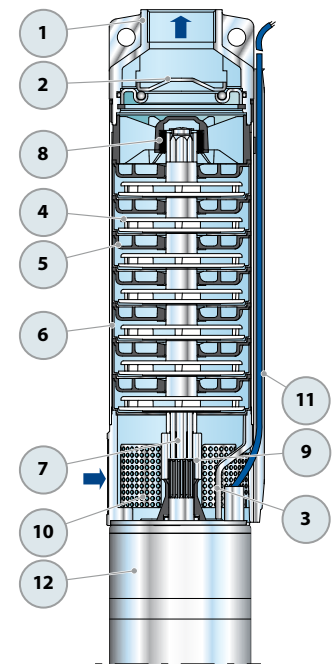

EJEMPLO DE INSTALACION

- 1) Electrobomba sumergida
- 2) Cintas para fijar el cable de alimentación
- 3) Sondas control nivel contra la marcha en seco
- 4) Soporte y cable de anclaje
- 5) Manómetro
- 6) Válvula de retención
- 7) Válvula de compuerta del caudal
- 8) Cable de alimentación eléctrica
- 9) Cuadro eléctrico
- 10) Depósito autoclave
- 11) Presóstato
- 12) Electro-válvula/electro-compresor

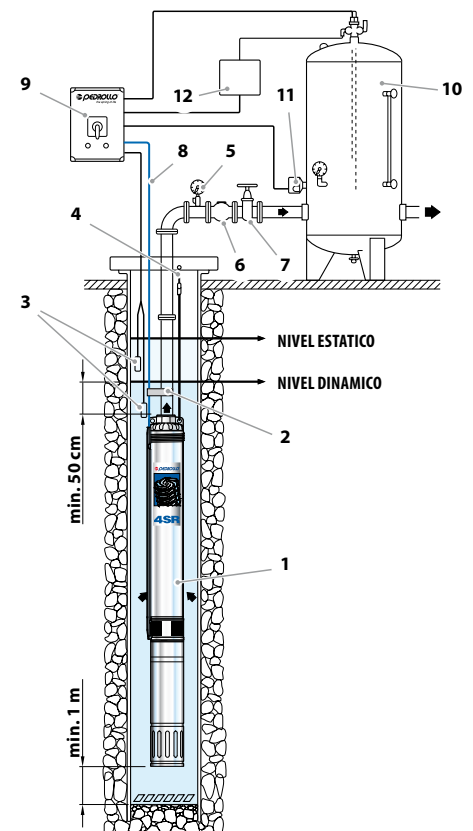
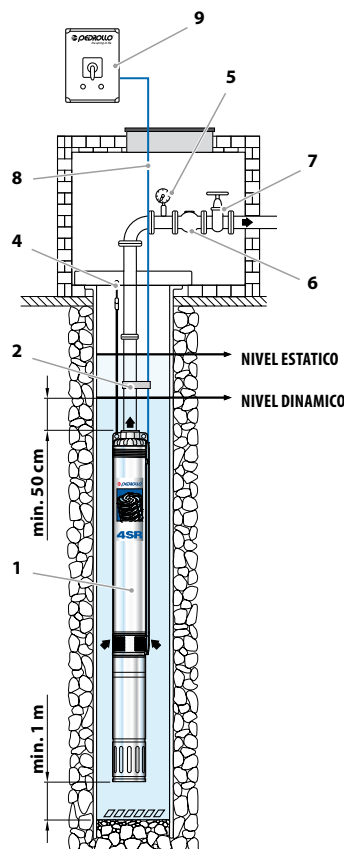

► La instalación de las electrobombas **4SR** es apta para pozos con un diámetro no inferior a 4" (100 mm). La electrobomba sumergida se baja al pozo mediante el tubo de impulsión hasta una profundidad tal que garantice su total inmersión (min, 50 cm y por lo menos 1 metro desde el fondo del pozo) incluso mientras funciona, cuando se aprecia una disminución del líquido en el pozo. Cuando la electrobomba sumergida se instala en un pozo, se aconseja asegurarla con un cable de acero inoxidable para conectarla a los específicos enganches de la boca de impulsión.

DIMENSIONES Y PESOS

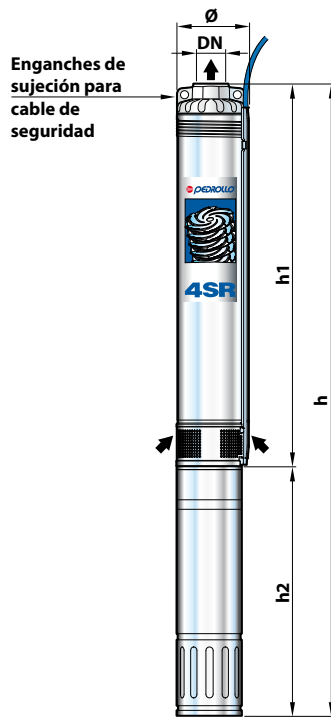

MODELO	BOCA	DIMENSIONES mm				kg
Monofásica	DN	Ø	h1	h2	h	1~
4SR1m/13 - PD	1 1/4"	98	400	311	711	11.2
4SR1m/18 - PD			517	331	848	13.2
4SR1m/25 - PD			646	356	1002	15.9
4SR1m/35 - PD			856	396	1252	19.6
4SR1m/45 - PD			1065	437	1502	23.1
4SR1.5m/8 - PD			308	311	619	10.3
4SR1.5m/13 - PD			400	331	731	11.7
4SR1.5m/17 - PD			499	356	855	14.2
4SR1.5m/25 - PD			646	396	1042	17.5
4SR1.5m/32 - PD			800	437	1237	20.9
4SR1.5m/46 - PD			1134	492	1626	28.1
4SR2m/7 - PD			290	311	601	10.1
4SR2m/10 - PD			345	331	676	11.4
4SR2m/13 - PD			400	356	756	13.3
4SR2m/20 - PD			554	396	950	16.6
4SR2m/27 - PD			683	437	1120	19.5
4SR2m/39 - PD			929	492	1421	25.4
4SR4m/7 - PD			314	331	645	11.0
4SR4m/9 - PD			358	356	714	12.8
4SR4m/14 - PD			468	396	864	15.6
4SR4m/18 - PD	580	437	1017	18.3		
4SR4m/26 - PD	756	492	1248	23.2		
4SR6m/4 - PD	2"	98	281	331	612	10.9
4SR6m/6 - PD			341	356	697	12.5
4SR6m/9 - PD			431	396	827	15.0
4SR6m/13 - PD			576	437	1013	17.8
4SR6m/17 - PD			695	492	1187	22.2
4SR8m/4 - PD			281	356	637	12.0
4SR8m/7 - PD			371	396	767	14.4
4SR8m/9 - PD			431	437	868	16.4
4SR8m/13 - PD			576	492	1068	21.0
4SR10m/6 -N - PD			616	356	972	14.0
4SR10m/8 -N - PD			762	396	1158	16.9
4SR10m/11 -N - PD			981	437	1418	20.2
4SR10m/16 -N - PD	1346	492	1838	26.4		
4SR12m/5 -N - PD	543	356	899	13.4		
4SR12m/7 -N - PD	689	396	1085	16.3		
4SR12m/9 -N - PD	835	437	1272	19.0		
4SR12m/14 -N - PD	1200	492	1692	25.2		
4SR15m/6 -N - PD	616	396	1012	15.7		
4SR15m/8 -N - PD	762	437	1199	18.4		
4SR15m/12 -N - PD	1054	492	1546	24.0		

MODELO	BOCA	DIMENSIONES mm				kg
Trifásica	DN	Ø	h1	h2	h	3~
4SR1/13 - PD	1 1/4"	98	400	311	711	11.2
4SR1/18 - PD			517	331	848	13.2
4SR1/25 - PD			646	356	1002	15.9
4SR1/35 - PD			856	396	1227	18.8
4SR1/45 - PD			1065	396	1461	21.6
4SR1.5/8 - PD			308	311	619	10.3
4SR1.5/13 - PD			400	331	731	11.7
4SR1.5/17 - PD			499	356	855	14.2
4SR1.5/25 - PD			646	371	1017	16.7
4SR1.5/32 - PD			800	396	1196	19.4
4SR1.5/46 - PD			1134	437	1571	24.9
4SR2/7 - PD			290	311	601	10.1
4SR2/10 - PD			345	331	676	11.4
4SR2/13 - PD			400	356	756	13.3
4SR2/20 - PD			554	371	925	15.8
4SR2/27 - PD			683	396	1079	18.0
4SR2/39 - PD			929	437	1366	22.2
4SR4/7 - PD			314	331	645	11.0
4SR4/9 - PD			358	356	714	12.8
4SR4/14 - PD			468	371	839	14.8
4SR4/18 - PD	580	396	976	16.8		
4SR4/26 - PD	756	437	1193	20.0		
4SR4/35 - PD	978	450	1428	23.9		
4SR4/46 - PD	1295	505	1800	31.1		
4SR4/60 - PD	1652	700	2352	44.1		
4SR6/4 - PD	2"	98	281	331	612	10.9
4SR6/6 - PD			341	356	697	12.5
4SR6/9 - PD			431	371	802	14.2
4SR6/13 - PD			576	396	972	16.3
4SR6/17 - PD			695	437	1132	19.0
4SR6/23 - PD			900	450	1350	22.5
4SR6/31 - PD			1164	505	1669	27.7
4SR6/42 - PD			1519	700	2219	40.4
4SR6/56 - PD			2063	800	2863	51.0
4SR8/4 - PD			281	356	637	12.0
4SR8/7 - PD			371	371	742	13.6
4SR8/9 - PD			431	396	827	14.9
4SR8/13 - PD			576	437	1013	17.8
4SR8/17 - PD			695	450	1145	20.4
4SR8/23 - PD			900	505	1405	25.4
4SR8/31 - PD			1164	700	1864	36.5
4SR8/42 - PD			1519	800	2319	43.9
4SR10/6 -N - PD			616	356	972	14.0
4SR10/8 -N - PD			762	371	1133	16.1
4SR10/11 -N - PD			981	396	1377	18.7
4SR10/16 -N - PD	1346	437	1783	23.2		
4SR10/22 -N - PD	1784	450	2234	28.2		
4SR10/30 -N - PD	2368	505	2873	36.1		
4SR10/41 -N - PD	3171	700	3871	51.2		
4SR12/5 -N - PD	543	356	899	13.4		
4SR12/7 -N - PD	689	371	1060	15.5		
4SR12/9 -N - PD	835	396	1231	17.5		
4SR12/14 -N - PD	1200	437	1637	22.0		
4SR12/19 -N - PD	1565	450	2015	26.5		
4SR12/25 -N - PD	2003	505	2508	32.9		
4SR12/34 -N - PD	2660	700	3360	46.9		
4SR15/6 -N - PD	616	371	987	14.9		
4SR15/8 -N - PD	762	396	1158	16.9		
4SR15/12 -N - PD	1054	437	1491	20.8		
4SR15/16 -N - PD	1346	450	1796	24.7		
4SR15/21 -N - PD	1711	505	2216	30.5		
4SR15/29 -N - PD	2295	700	2995	43.9		

DIMENSIONES Y PESOS

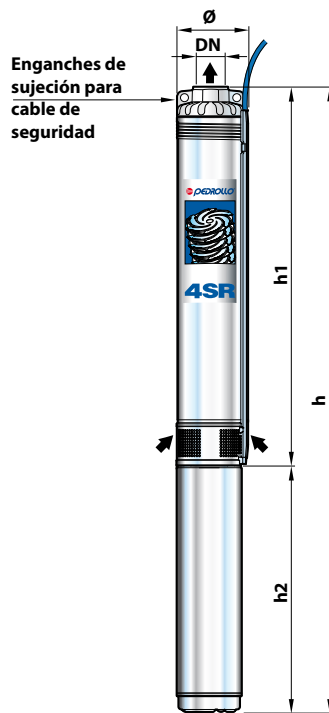

MODELO	BOCA	DIMENSIONES mm			kg	
Monofásica	DN	Ø	h1	h2	h	1~
4SR1m/13 - PS	1 1/4"	98	400	237	637	11.5
4SR1m/18 - PS			517	257	774	13.9
4SR1m/25 - PS			646	272	918	16.5
4SR1m/35 - PS			856	312	1168	20.6
4SR1m/45 - PS			1065	352	1417	24.8
4SR1.5m/8 - PS			308	237	545	10.6
4SR1.5m/13 - PS			400	257	657	12.4
4SR1.5m/17 - PS			499	272	771	14.8
4SR1.5m/25 - PS			646	312	958	18.5
4SR1.5m/32 - PS			800	352	1152	22.6
4SR1.5m/46 - PS			1134	402	1536	27.4
4SR2m/7 - PS			290	237	527	10.4
4SR2m/10 - PS			345	257	602	12.1
4SR2m/13 - PS			400	272	672	13.9
4SR2m/20 - PS			554	312	866	17.6
4SR2m/27 - PS			683	352	1035	21.2
4SR2m/39 - PS	929	402	1331	24.7		
4SR4m/7 - PS	2"	98	314	257	571	11.7
4SR4m/9 - PS			358	272	630	13.4
4SR4m/14 - PS			468	312	780	16.6
4SR4m/18 - PS			580	352	932	20.0
4SR4m/26 - PS			756	402	1158	22.5
4SR6m/4 - PS			281	257	538	11.6
4SR6m/6 - PS			341	272	613	13.1
4SR6m/9 - PS			431	312	743	16.0
4SR6m/13 - PS			576	352	928	19.5
4SR6m/17 - PS			695	402	1097	21.5
4SR8m/4 - PS			281	272	553	12.6
4SR8m/7 - PS			371	312	683	15.4
4SR8m/9 - PS	431	352	783	18.1		
4SR8m/13 - PS	576	402	978	20.3		
4SR10m/6 -N - PS	616	272	888	14.6		
4SR10m/8 -N - PS	762	312	1074	17.9		
4SR10m/11 -N - PS	981	352	1333	21.9		
4SR10m/16 -N - PS	1346	402	1748	25.7		
4SR12m/5 -N - PS	543	272	815	14.0		
4SR12m/7 -N - PS	689	312	1001	17.3		
4SR12m/9 -N - PS	835	352	1187	20.7		
4SR12m/14 -N - PS	1200	402	1602	24.5		
4SR15m/6 -N - PS	616	312	928	16.7		
4SR15m/8 -N - PS	762	352	1114	20.1		
4SR15m/12 -N - PS	1054	402	1456	23.3		

MODELO	BOCA	DIMENSIONES mm			kg	
Trifásica	DN	Ø	h1	h2	h	3~
4SR1/13 - PS	1 1/4"	98	400	237	637	11.5
4SR1/18 - PS			517	237	754	12.8
4SR1/25 - PS			646	257	903	15.3
4SR1/35 - PS			856	272	1128	18.5
4SR1/45 - PS			1065	297	1362	22.6
4SR1.5/8 - PS			308	237	545	10.6
4SR1.5/13 - PS			400	237	637	11.3
4SR1.5/17 - PS			499	257	756	13.6
4SR1.5/25 - PS			646	272	918	16.4
4SR1.5/32 - PS			800	297	1097	20.4
4SR1.5/46 - PS			1134	352	1486	26.6
4SR2/7 - PS			290	237	527	10.4
4SR2/10 - PS			345	237	582	11.0
4SR2/13 - PS			400	257	657	12.7
4SR2/20 - PS			554	272	826	15.5
4SR2/27 - PS			683	297	980	19.0
4SR2/39 - PS			929	352	1281	23.9
4SR4/7 - PS			314	237	551	10.6
4SR4/9 - PS			358	257	615	12.2
4SR4/14 - PS			468	272	740	14.5
4SR4/18 - PS			580	297	877	17.8
4SR4/26 - PS			756	352	1108	21.7
4SR4/35 - PS			978	484	1462	24.0
4SR4/46 - PS			1295	574	1869	38.4
4SR4/60 - PS	1652	664	2316	47.2		
4SR6/4 - PS	2"	98	281	237	518	10.5
4SR6/6 - PS			341	257	598	11.9
4SR6/9 - PS			431	272	703	13.9
4SR6/13 - PS			576	297	873	17.3
4SR6/17 - PS			695	352	1047	20.7
4SR6/23 - PS			900	484	1384	22.6
4SR6/31 - PS			1164	574	1738	35.0
4SR6/42 - PS			1519	664	2183	43.5
4SR6/56 - PS			2063	764	2827	53.4
4SR8/4 - PS			281	257	538	11.4
4SR8/7 - PS			371	272	643	13.3
4SR8/9 - PS			431	297	728	15.9
4SR8/13 - PS			576	352	928	19.5
4SR8/17 - PS			695	484	1179	20.5
4SR8/23 - PS			900	574	1474	32.7
4SR8/31 - PS			1164	664	1828	39.6
4SR8/42 - PS			1519	764	2283	46.3
4SR10/6 -N - PS			616	257	873	13.4
4SR10/8 -N - PS	762	272	1034	15.8		
4SR10/11 -N - PS	981	297	1278	19.7		
4SR10/16 -N - PS	1346	352	1698	24.9		
4SR10/22 -N - PS	1784	484	2268	28.3		
4SR10/30 -N - PS	2368	574	2942	43.4		
4SR10/41 -N - PS	3171	664	3835	54.3		
4SR12/5 -N - PS	543	257	800	12.8		
4SR12/7 -N - PS	689	272	961	15.2		
4SR12/9 -N - PS	835	297	1132	18.5		
4SR12/14 -N - PS	1200	352	1552	23.7		
4SR12/19 -N - PS	1565	484	2049	26.6		
4SR12/25 -N - PS	2003	574	2577	40.2		
4SR12/34 -N - PS	2660	664	3324	50.0		
4SR15/6 -N - PS	616	272	888	14.6		
4SR15/8 -N - PS	762	297	1059	17.9		
4SR15/12 -N - PS	1054	352	1406	22.5		
4SR15/16 -N - PS	1346	484	1830	24.8		
4SR15/21 -N - PS	1711	574	2285	37.8		
4SR15/29 -N - PS	2295	664	2959	47.0		

DIMENSIONES Y PESOS (SOLO HIDRAULICA)



MODELO Pompa	BOCA DN	DIMENSIONES mm			kg
		Ø	h1	h	
4SR1/13 - HYD	1¼"	98	400	403	4.7
4SR1/18 - HYD			517	520	6.0
4SR1/25 - HYD			646	649	7.4
4SR1/35 - HYD			856	859	9.4
4SR1/45 - HYD			1065	1068	11.4
4SR1.5/8 - HYD			308	311	3.8
4SR1.5/13 - HYD			400	403	4.5
4SR1.5/17 - HYD			499	502	5.7
4SR1.5/25 - HYD			646	649	7.3
4SR1.5/32 - HYD			800	803	9.2
4SR1.5/46 - HYD			1134	1137	13.2
4SR2/7 - HYD			290	293	3.6
4SR2/10 - HYD			345	348	4.2
4SR2/13 - HYD			400	403	4.8
4SR2/20 - HYD			554	557	6.4
4SR2/27 - HYD			683	686	7.8
4SR2/39 - HYD			929	932	10.5
4SR4/7 - HYD			314	317	3.8
4SR4/9 - HYD			358	361	4.3
4SR4/14 - HYD			468	471	5.4
4SR4/18 - HYD			580	583	6.6
4SR4/26 - HYD			756	759	8.3
4SR4/35 - HYD			978	981	10.7
4SR4/46 - HYD			1295	1298	15.0
4SR4/60 - HYD	1652	1655	19.4		
4SR6/4 - HYD	2"	98	281	284	3.7
4SR6/6 - HYD			341	344	4.0
4SR6/9 - HYD			431	434	4.8
4SR6/13 - HYD			576	579	6.1
4SR6/17 - HYD			695	698	7.3
4SR6/23 - HYD			900	903	9.3
4SR6/31 - HYD			1164	1167	11.6
4SR6/42 - HYD			1519	1522	15.7
4SR6/56 - HYD			2063	2066	22.0
4SR8/4 - HYD			281	284	3.5
4SR8/7 - HYD			371	374	4.2
4SR8/9 - HYD			431	434	4.7
4SR8/13 - HYD	576	579	6.1		
4SR8/17 - HYD	695	698	7.2		
4SR8/23 - HYD	900	903	9.3		
4SR8/31 - HYD	1164	1167	11.8		
4SR8/42 - HYD	1519	1522	14.9		
4SR10/6 -N - HYD	2"	98	616	619	5.5
4SR10/8 -N - HYD			762	765	6.7
4SR10/11 -N - HYD			981	984	8.5
4SR10/16 -N - HYD			1346	1349	11.5
4SR10/22 -N - HYD			1784	1787	15.0
4SR10/30 -N - HYD			2368	2371	20.0
4SR10/41 -N - HYD			3171	3174	26.5
4SR12/5 -N - HYD			543	546	4.9
4SR12/7 -N - HYD			689	692	6.1
4SR12/9 -N - HYD			835	838	7.3
4SR12/14 -N - HYD			1200	1203	10.3
4SR12/19 -N - HYD			1565	1568	13.3
4SR12/25 -N - HYD			2003	2006	16.8
4SR12/34 -N - HYD			2660	2663	22.2
4SR15/6 -N - HYD			616	619	5.5
4SR15/8 -N - HYD	762	765	6.7		
4SR15/12 -N - HYD	1054	1057	9.1		
4SR15/16 -N - HYD	1346	1349	11.5		
4SR15/21 -N - HYD	1711	1714	14.4		
4SR15/29 -N - HYD	2295	2298	19.2		