	Product Information ABK200	Manufacturer	LEO
		Address	China,Zhejiang,Wenling
		Contact	0576-89988888
		Date	2023/08/18
Project Name		Client Name	koslan
		Client Addr.	
Item NO		Contacts	luis guajardo
		Contact	

Part NO.	50029773
----------	----------

Product Picture	Note
	<p>High efficiency; Low noise;Simple in struction and operation Can be used to transfer liquids with light corrosive,requirement for health and containing impurities,etc. Suitable for industrial & domestic sewage system,food & beverage processing,farming,pumping water from river and lake,etc. Can be used at full head without overloading motor.</p>

Nameplate parameters

flow	24 m ³ /h
head	10 m
Efficiency	40 %
speed	2900 rpm
number of stages	1

Technical

Flow range (m ³ /h)	642
Curve tolerance	ISO 9906 Annex A
Maximum lift (m)	13m



Material

Impeller	06Cr19Ni10
Pump inlet	06Cr19Ni10
bracket	ZL102
Bracket cover	06Cr19Ni10
Fan	PP+GF15
Fan cover	PP-GF10

Working conditions

Medium temperature (°C)	-15°C+80°C
Max. Particles Size	16mm
Max. ambient temperature (°C)	410
Pumped medium	Clean, thin, non-corrosive, non-flammable, non-explosive, Not easy vaporizationLiquid without solid
Working pressure	8Bar

Installation

Inlet / outlet dia.	G Thread
Inlet diameter (mm)	G2
Outlet diameter (mm)	G2
Connection standard	Internal thread
Rotation direction	Clockwise from drive end

Motor

Motor phase	Three phase
Protection class	IPX4
Motor poles	2
Insulation class	F
Motor power (KW)	1.5KW

	Product Information ABK200	Manufacturer	LEO
		Address	China,Zhejiang,Wenling
		Contact	0576-89988888
		Date	2023/08/18
Project Name		Client Name	koslan
		Client Addr.	
Item NO		Contacts	luis guajardo
		Contact	

Frequency 50Hz
 Rated voltage (V) 380 V
 Rated current (A) 4.3
 Drive end bearing 6304-2RZ
 Non-drive end bearing 6204-2RZ
 Efficiency (%) 81.3%

Seal

Mechanical seal PB20Y-20BP

Weight/Packaging

Gross weight (kg) 14.5Kg
 Package size 420*235*265mm



	Performance Curve ABK200	Manufacturer	LEO
		Address	China,Zhejiang,Wenling
		Contact	0576-89988888
		Date	2023/08/18
Project Name		Client Name	koslan
Item NO		Client Addr.	
		Contacts	luis guajardo
		Contact	

The hydraulic performance curve have been tested with Water at $^{\circ}\text{C}$, density $1000\text{kg}/\text{m}^3$, and at 1bar atmospheric pressure. GB32162016 Grande 3B

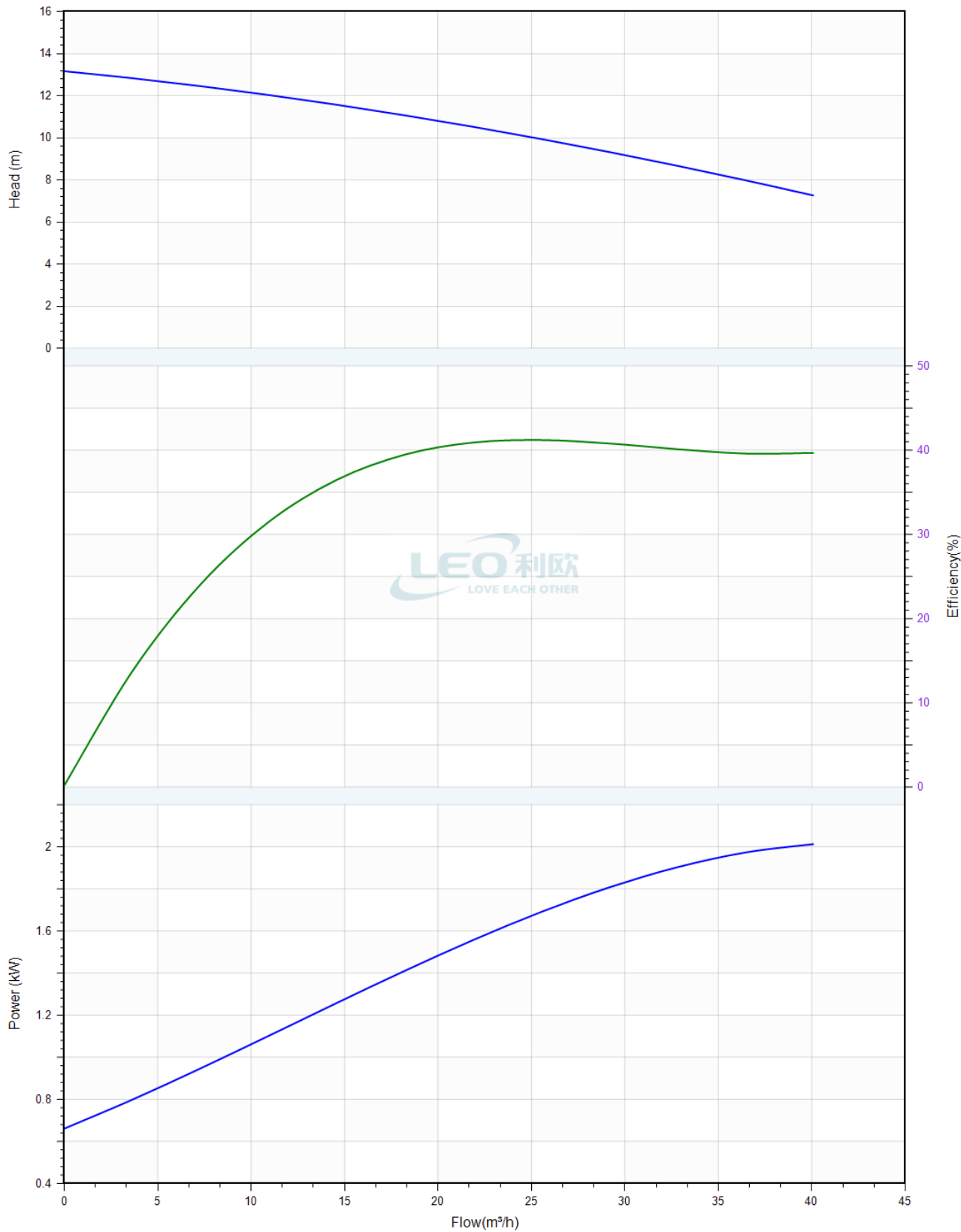



Pump Technical Parameters ABK200

Manufacturer	LEO
Address	China,Zhejiang,Wenling
Contact	0576-89988888
Date	2023/08/18
Client Name	koslan
Client Addr.	
Contacts	luis guajardo
Contact	

Project Name

Item NO

Rated parameters

Pump model	ABK200
Part NO.	50029773
Rated flow	24 m ³ /h
Rated head	10 m
Rated efficiency (%)	40
Power (kW)	1.64
Speed (rpm)	2900

Medium

Pumped medium	Water
Working temperature (°C)	20
Medium density (kg/m ³)	1000
Viscosity (mm ² /s)	1

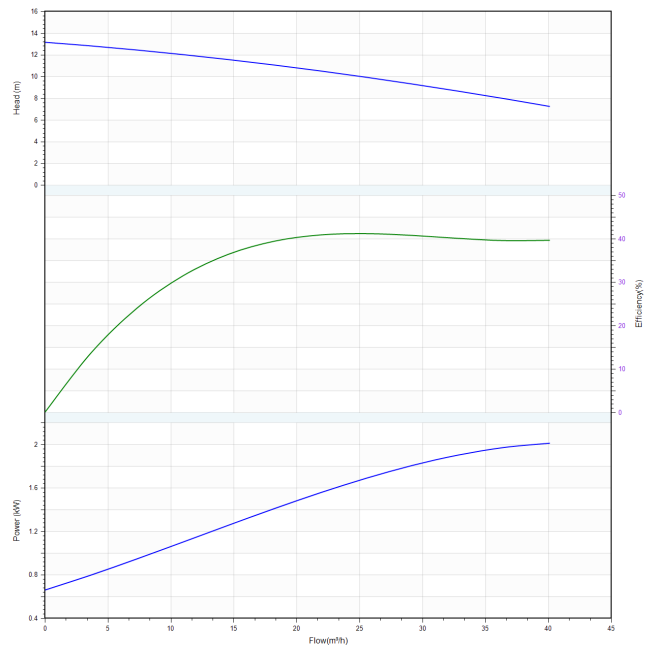



Installation picture
ABK200

Manufacturer	LEO
Address	China,Zhejiang,Wenling
Contact	0576-89988888
Date	2023/08/18
Client Name	koslan
Client Addr.	
Contacts	luis guajardo
Contact	

Project Name

Item NO

ABK200 (D)

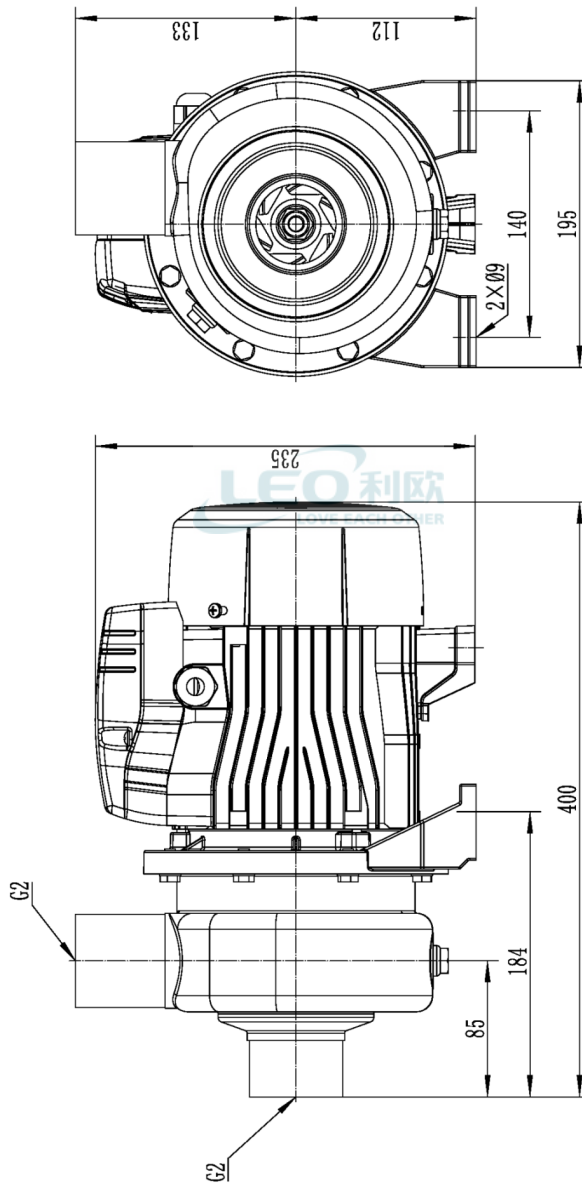

	Physical picture ABK200	Manufacturer	LEO
		Address	China,Zhejiang,Wenling
		Contact	0576-89988888
		Date	2023/08/18
Project Name		Client Name	koslan
Item NO		Client Addr.	
		Contacts	luis guajardo
		Contact	

