

	Product Information ABK300	Manufacturer	LEO
		Address	China,Zhejiang,Wenling
		Contact	0576-89988888
		Date	2023/10/17
Project Name		Client Name	koslan
Item NO		Client Addr.	
		Contacts	luis guajardo
		Contact	

Part NO.	50029774
----------	----------

Product Picture	Note
	<p>High efficiency; Low noise;Simple in struction and operation Can be used to transfer liquids with light corrosive,requirement for health and containing impurities,etc. Suitable for industrial & domestic sewage system,food & beverage processing,farming,pumping water from river and lake,etc. Can be used at full head without overloading motor.</p>

Nameplate parameters	
flow	42 m ³ /h
head	9.8 m
Efficiency	43 %
speed	2900 rpm
number of stages	1
Technical	
Flow range (m ³ /h)	657
Curve tolerance	ISO 9906 Annex A
Maximum lift (m)	15m
	
Material	
Impeller	06Cr19Ni10
Pump inlet	06Cr19Ni10
bracket	ZL102
Bracket cover	06Cr19Ni10
Fan	PP+GF15
Fan cover	PP-GF10
Working conditions	
Medium temperature (°C)	-15°C+80°C
Max. Particles Size	16mm
Max. ambient temperature (°C)	410
Pumped medium	Clean, thin, non-corrosive, non-flammable, non-explosive, Not easy vaporizationLiquid without solid
Working pressure	8Bar
Installation	
Inlet / outlet dia.	G Thread
Inlet diameter (mm)	G21/2
Outlet diameter (mm)	G2
Connection standard	Internal thread
Rotation direction	Clockwise from drive end
Motor	
Motor phase	Three phase
Protection class	IPX4
Motor poles	2
Insulation class	F
Motor power (KW)	2.2KW

	Product Information ABK300	Manufacturer	LEO
		Address	China,Zhejiang,Wenling
		Contact	0576-89988888
		Date	2023/10/17
Project Name		Client Name	koslan
		Client Addr.	
Item NO		Contacts	luis guajardo
		Contact	

Frequency	50Hz
Rated voltage (V)	380 V
Rated current (A)	5.5
Drive end bearing	6305-2RZ
Non-drive end bearing	6205-2RZ
Efficiency (%)	83.2%
Seal	
Mechanical seal	PB20Y-20BP
Weight/Packaging	
Gross weight (kg)	20.4Kg
Package size	475*230*275mm



	Performance Curve ABK300	Manufacturer	LEO
		Address	China,Zhejiang,Wenling
		Contact	0576-89988888
		Date	2023/10/17
Project Name		Client Name	koslan
Item NO		Client Addr.	
		Contacts	luis guajardo
		Contact	

The hydraulic performance curve have been tested with Water at $^{\circ}\text{C}$, density $1000\text{kg}/\text{m}^3$, and at 1bar atmospheric pressure. GB32162016 Grande 3B

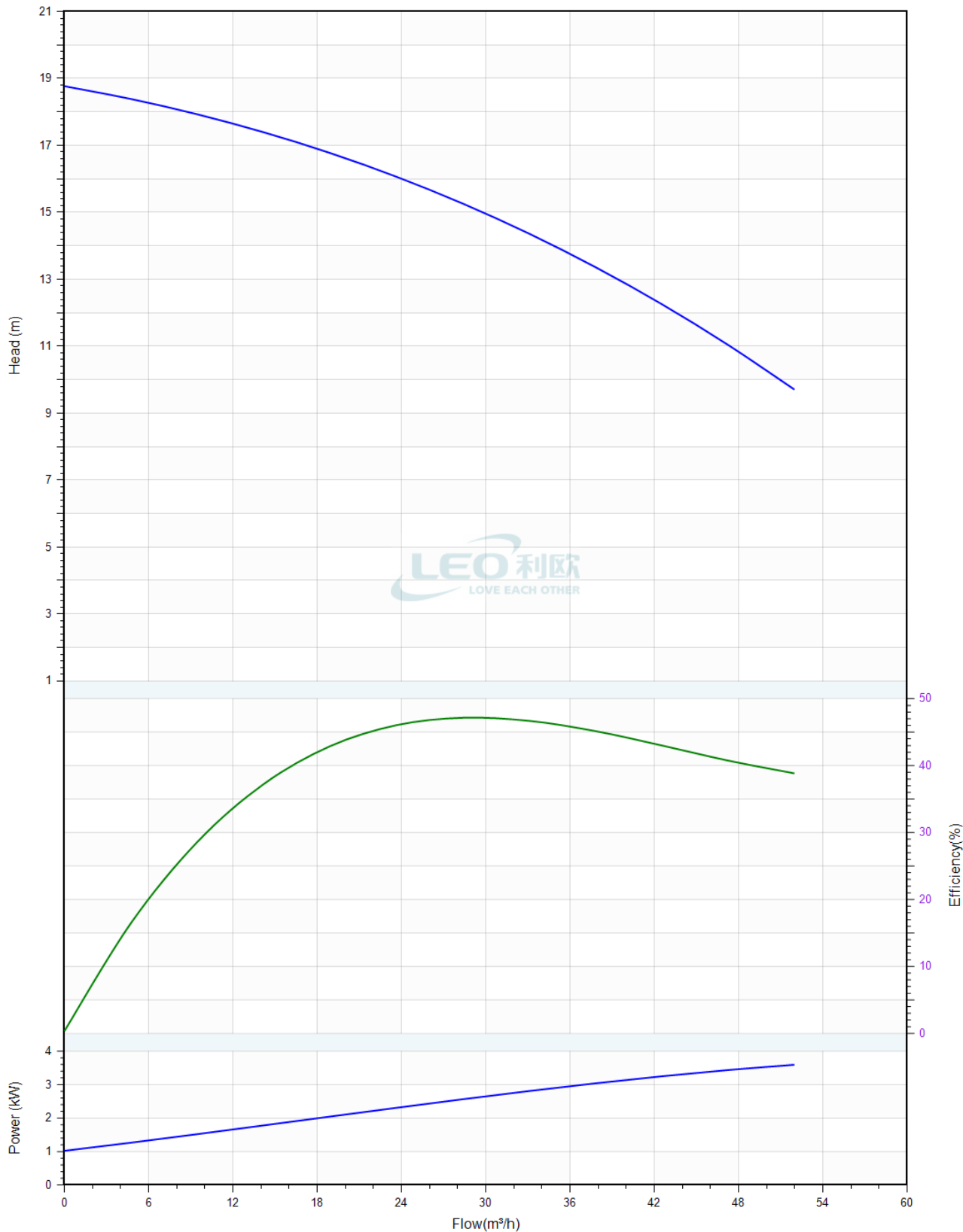



Pump Technical Parameters ABK300

Manufacturer	LEO
Address	China,Zhejiang,Wenling
Contact	0576-89988888
Date	2023/10/17

Project Name

Client Name	koslan
Client Addr.	

Item NO

Contacts	luis guajardo
Contact	

Rated parameters

Pump model	ABK300
Part NO.	50029774
Rated flow	42 m ³ /h
Rated head	9.8 m
Rated efficiency (%)	43
Power (kW)	2.61
Speed (rpm)	2900

Medium

Pumped medium	Water
Working temperature (°C)	20
Medium density (kg/m ³)	1000
Viscosity (mm ² /s)	1

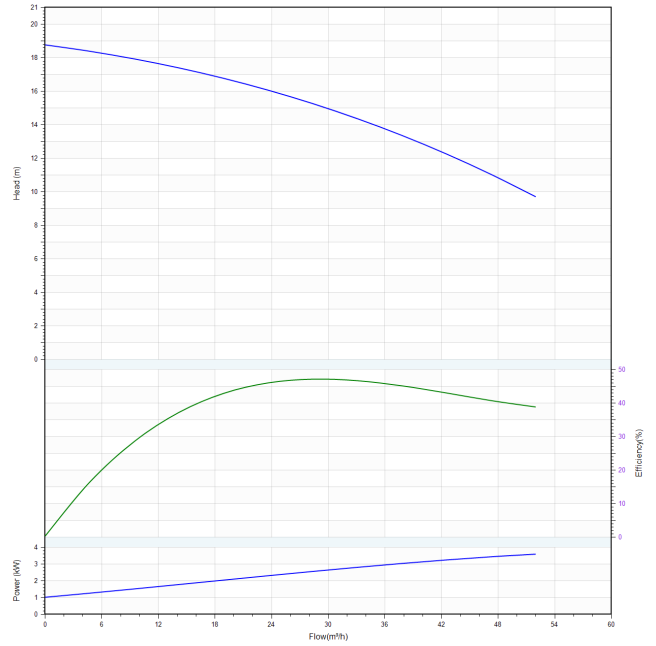



Installation picture
ABK300

Manufacturer	LEO
Address	China,Zhejiang,Wenling
Contact	0576-89988888
Date	2023/10/17

Project Name

Client Name	koslan
Client Addr.	

Item NO

Contacts	luis guajardo
Contact	

ABK300 (D)

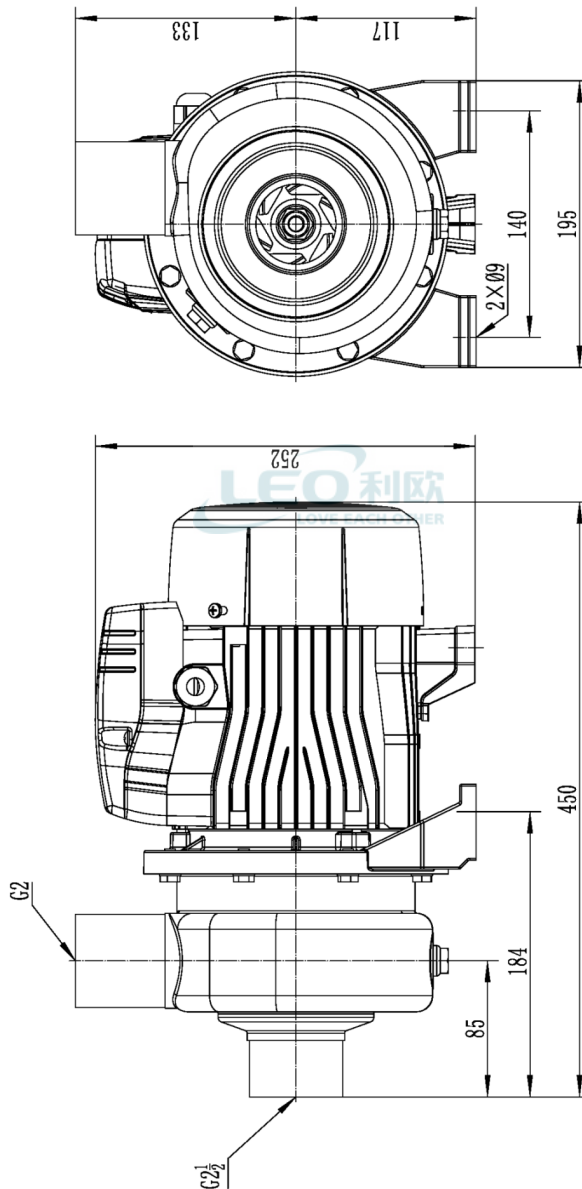

	Physical picture ABK300	Manufacturer	LEO
		Address	China,Zhejiang,Wenling
		Contact	0576-89988888
		Date	2023/10/17
Project Name		Client Name	koslan
Item NO		Client Addr.	
		Contacts	luis guajardo
		Contact	

