

MODEL	POWER	POWER (W)	Max. Flow (l/min)	Max. Head (m)	Inlet/Outlet (mm)	Pipe Size (inch)
LRP15-90A/160	1~230V/50Hz	123	25	9	Φ15	1

Materials Table

No.	Part	Material
1	Rotor	
2	Thrust bearing adjusting mat	Noryl
3	Thrust bearing rubber mat	Silicon rubber
4	Thrust bearing	Graphite
5	Front bearing	Alumina
6	Pump support cover	Stainless steel
7	Check ball	Silicon rubber
8	Impeller	PPO
9	Pump body	Cast iron/bronze
10	Pump body insert	Stainless steel
11	Body gasket	
12	Rear bearing	HT200
13	Can brg asm	Stainless steel
14	Can brg asm seal	Silicon rubber
15	Stator cover(front)	PA66
16	Motor stator with winding	
17	Stator cover(back)	PA66
18	Housing	ADC12
19	Cable outlet nut	ABS
20	Button	ABS
21	Terminal box	PA6
22	Regulation switch	
23	Capacitor	
24	Terminal cover	ABS
25	Flow switch assembly	

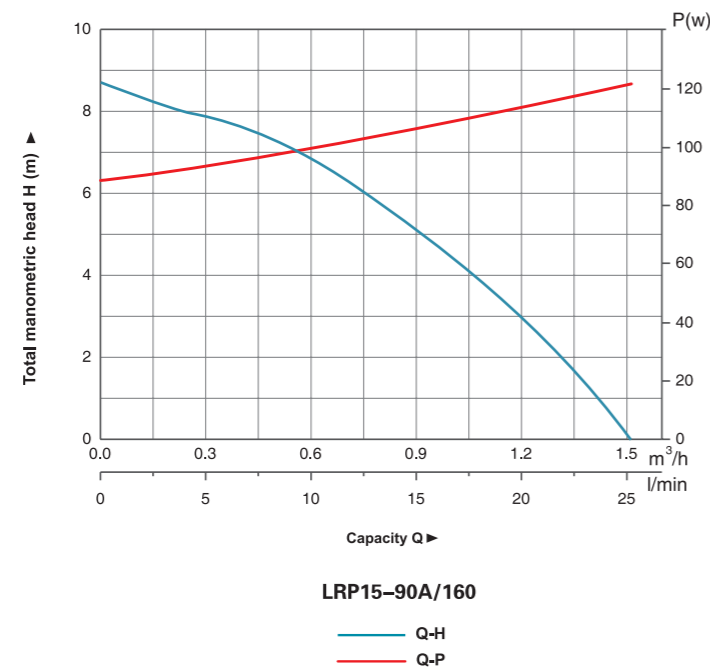
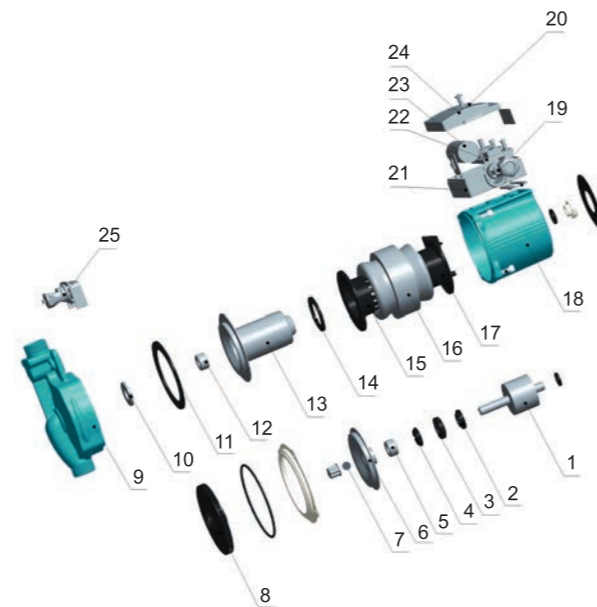

Application

- It is widely used for heating ventilating and air conditioning (HVAC) circulation, pressure boosting of hot water in family, homes powered by solar energy, industrial auxiliary equipment cold and hot water circulation and so forth
- Water circulation for the central and district heating system
- Domestic hot water circulation

Pump

- Bronze or anti-rust cast iron pump body
- Noryl impeller with heat resistance up to 150°C
- 99% alumina ceramic shaft
- Liquid temperature: 2°C - 110°C

Motor

- Insulation class: H
- Protection class: IP44
- 99% alumina ceramic bearing
- Copper winding
- Three speed motor



MODEL	A (mm)	B (mm)	C (mm)	D
LRP15-40/130	130	130	125	G1
LRP15-40B/130	130	130	125	G1
LRP20-40/130	130	130	125	G1.25
LRP25-40/130	130	130	125	G1.5
LRP25-40/180	130	180	125	G1.5
LRP32-40/180	135	180	125	G2
LRP15-50/130	130	130	125	G1
LRP15-50B/130	130	130	125	G1
LRP20-50/130	130	130	125	G1.25
LRP25-50/130	130	130	125	G1.5
LRP25-50/180	130	180	125	G1.5
LRP32-50/180	135	180	125	G2
LRP15-60/130	130	130	125	G1
LRP15-60B/130	130	130	125	G1
LRP20-60/130	130	130	125	G1.25
LRP25-60/130	130	130	125	G1.5
LRP25-60/180	130	180	125	G1.5
LRP32-60/180	135	180	125	G2
LRP25-70/130	130	130	125	G1.5
LRP25-70/180	130	180	125	G1.5
LRP32-70/180	135	180	125	G2
LRP25-80/180	154	180	134	G1.5
LRP25-120/180	155	180	148	G1.5
LRP32-80/180	168	180	137	G2

Dimension Drawing

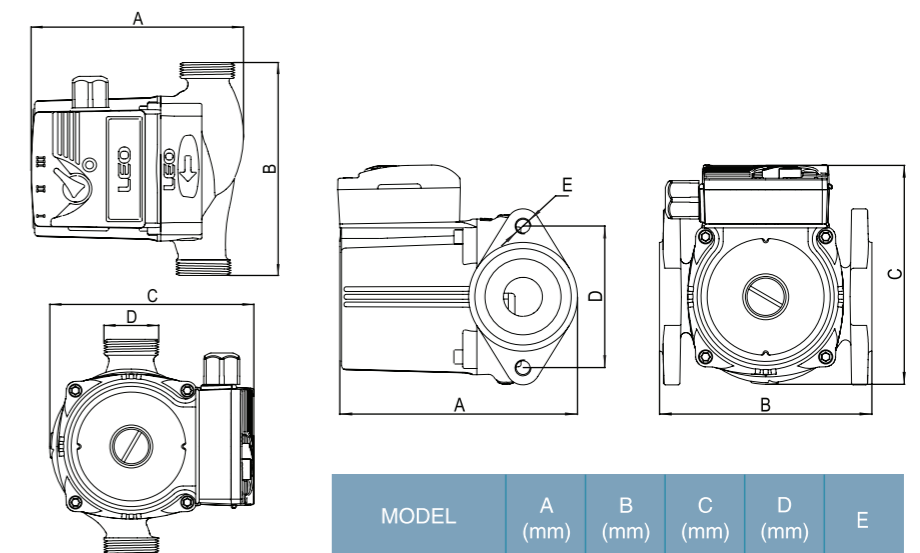

MODEL	A (mm)	B (mm)	C (mm)	D (mm)	E
LRP21-40F/120	130	120	125	80	M10
LRP21-50F/120	130	120	125	80	M10
LRP21-60F/120	130	120	125	80	M10
LRP21-70F/120	130	120	125	80	M10

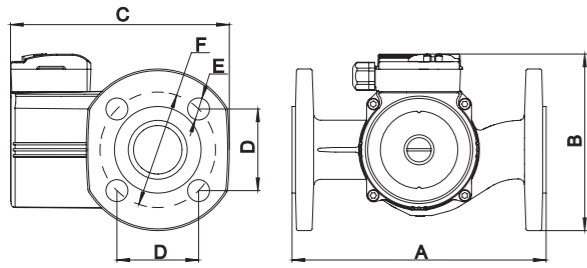

MODEL	A (mm)	B (mm)	C (mm)	D (mm)	E (mm)	F (mm)
LRP32-80F/220	220	150	191.5	70.7	Φ19	Φ100
LRP36-80F/200	200	138	174.5	63.6	Φ11.5	Φ90
LRP40-80F/250	250	155	196.5	77.8	Φ19	Φ110

Identification Codes

LRP 15 - 50 B / 130

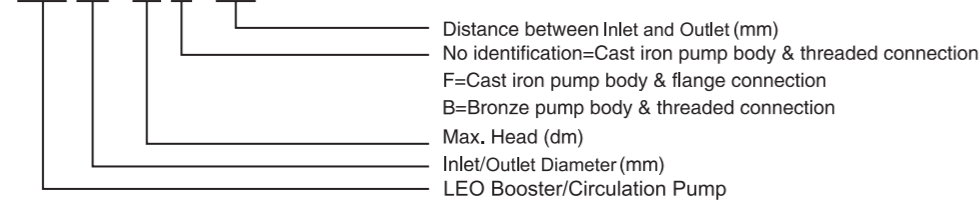

MODEL	POWER	POWER (W)			Max. Flow (l/min)	Max. Head (m)	Inet/Outlet (mm)	Pipe Size (inch)	N.W. (kgs)	G.W. (kgs)	Packing Size (mm)
		3	2	1							
LRP15-40/130	1~230V/50Hz	74	54	34	40/30/22	4.0/3.3/2.3	Φ15	1	2.32	2.45	154x143x153
LRP15-40B/130	1~230V/50Hz	74	54	34	40/30/22	4.0/3.3/2.3	Φ15	1	2.41	2.54	154x143x153
LRP20-40/130	1~230V/50Hz	74	54	34	45/35/25	4.0/3.3/2.3	Φ20	1.25	2.37	2.5	154x143x153
LRP21-40F/120	1~230V/50Hz	74	54	34	55/42/30	4.0/3.3/2.3	Φ21	1.25	2.65	2.78	154x143x153
LRP25-40/130	1~230V/50Hz	74	54	34	52/42/30	4.0/3.3/2.3	Φ25	1.5	2.44	2.57	154x143x153
LRP25-40/180	1~230V/50Hz	74	54	34	55/42/30	4.0/3.3/2.3	Φ25	1.5	2.55	2.705	198x143x160
LRP32-40/180	1~230V/50Hz	74	54	34	55/42/30	4.0/3.3/2.3	Φ32	2	2.73	2.885	198x143x160
LRP15-50/130	1~230V/50Hz	85	60	40	40/32/23	4.5/3.8/2.5	Φ15	1	2.32	2.45	154x143x153
LRP15-50B/130	1~230V/50Hz	85	60	40	40/32/23	4.5/3.8/2.5	Φ15	1	2.41	2.54	154x143x153
LRP20-50/130	1~230V/50Hz	85	60	40	47/37/25	4.5/3.8/2.5	Φ20	1.25	2.37	2.5	154x143x153
LRP21-50F/120	1~230V/50Hz	85	60	40	58/45/32	4.5/3.8/2.5	Φ21	1.25	2.65	2.78	154x143x153
LRP25-50/130	1~230V/50Hz	85	60	40	55/43/28	4.5/3.8/2.5	Φ25	1.5	2.44	2.57	154x143x153
LRP25-50/180	1~230V/50Hz	85	60	40	60/47/32	4.5/3.8/2.5	Φ25	1.5	2.55	2.705	198x143x160
LRP32-50/180	1~230V/50Hz	85	60	40	60/47/32	4.5/3.8/2.5	Φ32	2	2.73	2.885	198x143x160
LRP15-60/130	1~230V/50Hz	96	69	45	40/32/23	5.5/4.5/2.8	Φ15	1	2.32	2.45	154x143x153
LRP15-60B/130	1~230V/50Hz	96	69	45	40/32/23	5.5/4.5/2.8	Φ15	1	2.41	2.54	154x143x153
LRP20-60/130	1~230V/50Hz	96	69	45	53/37/25	5.5/4.5/2.8	Φ20	1.25	2.37	2.5	154x143x153
LRP21-60F/120	1~230V/50Hz	96	69	45	60/45/32	5.5/4.5/2.8	Φ21	1.25	2.65	2.78	154x143x153
LRP25-60/130	1~230V/50Hz	96	69	45	58/43/28	5.5/4.5/2.8	Φ25	1.5	2.44	2.57	154x143x153
LRP25-60/180	1~230V/50Hz	96	69	45	66/47/32	5.5/4.5/2.8	Φ25	1.5	2.55	2.705	198x143x160
LRP32-60/180	1~230V/50Hz	96	69	45	66/47/32	5.5/4.5/2.8	Φ32	2	2.73	2.885	198x143x160
LRP21-70F/120	1~230V/50Hz	150	130	105	67/50/37	6.3/6.0/5.2	Φ21	1.5	2.65	2.805	154x143x153
LRP25-70/130	1~230V/50Hz	150	130	105	67/50/37	6.3/6.0/5.2	Φ25	1.5	2.45	2.605	154x143x153
LRP25-70/180	1~230V/50Hz	150	130	105	67/50/37	6.3/6.0/5.2	Φ25	1.5	2.57	2.725	198x143x160
LRP32-70/180	1~230V/50Hz	150	130	105	67/50/34	6.3/6.0/5.2	Φ32	2	2.75	2.905	198x143x160
LRP25-80/180	1~230V/50Hz	200	190	160	120/100/60	7.1/6.5/5.5	Φ28	1.5	4.23	4.57	192x170x190
LRP32-80/180	1~230V/50Hz	270	245	160	167/100/60	7.3/6.7/5.4	Φ42	2	4.75	5.09	192x170x190
LRP32-80F/220	1~230V/50Hz	270	245	160	170/113/65	7.3/6.7/5.4	Φ42	2	7.57	8	235x181x207
LRP36-80F/200	1~230V/50Hz	270	245	160	170/113/65	7.3/6.7/5.4	Φ42	2	5.98	6.36	264x186x212
LRP40-80F/250	1~230V/50Hz	270	245	160	170/113/65	7.3/6.7/5.4	Φ42	2	8.27	8.74	192x170x190
LRP25-120/180	1~230V/50Hz	270	245	160	67/38/22.5	11.5/10/6.3	Φ18	1.5	4.62	4.96	192x170x190

Materials Table

No.	Part	Material
1	Rotor	
2	Thrust bearing adjusting mat	Noryl
3	Thrust bearing rubber mat	Silicon rubber
4	Thrust bearing	Graphite
5	Front bearing	Alumina
6	Pump support cover	Stainless steel
7	Check ball	Silicon rubber
8	Locking	Stainless steel
9	Impeller	PPO
10	Pump body	Cast iron/Bronze
11	Pump body insert	Stainless steel
12	Back bearing	Alumina
13	Can brg asm	Stainless steel
14	Can brg asm seal	Silicon rubber
15	Stator cover(front)	PA66
16	Stator	
17	Stator cover(back)	PA66
18	Pump shell	ADC12
19	Drain plug	Copper
20	Speed regulation board	
21	Terminal cover	ABS
22	Terminal box	PC
23	Capacitor	

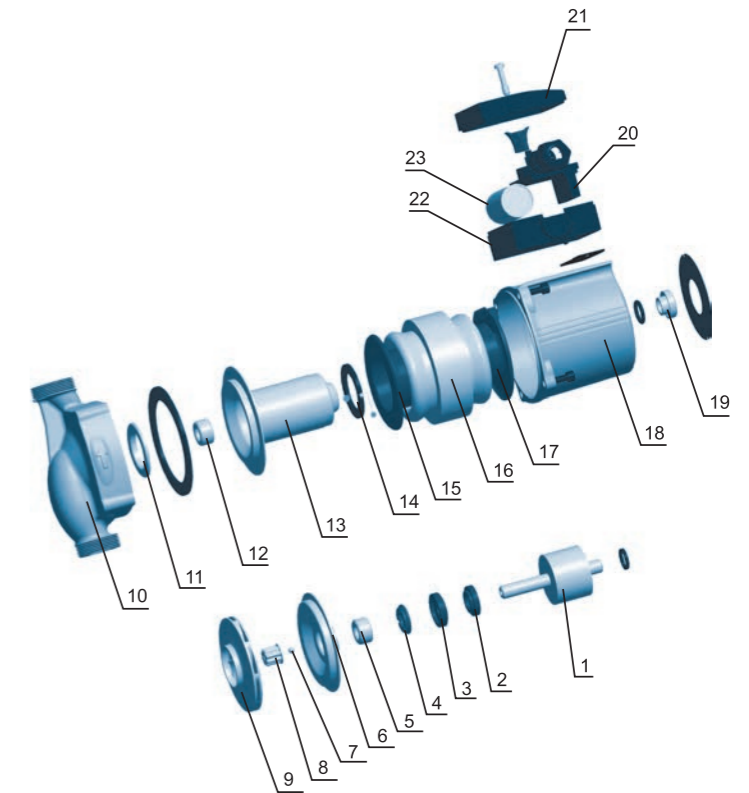

Hydraulic Performance Curves

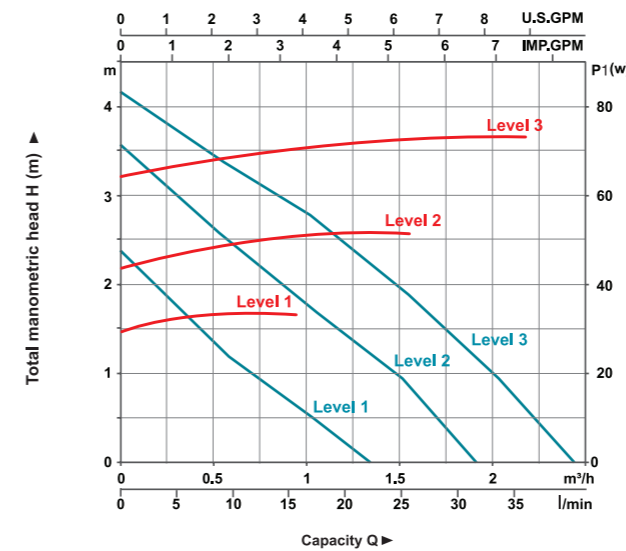

LRP15-40B/130
LRP15-40/130
— Q-H
— Q-P

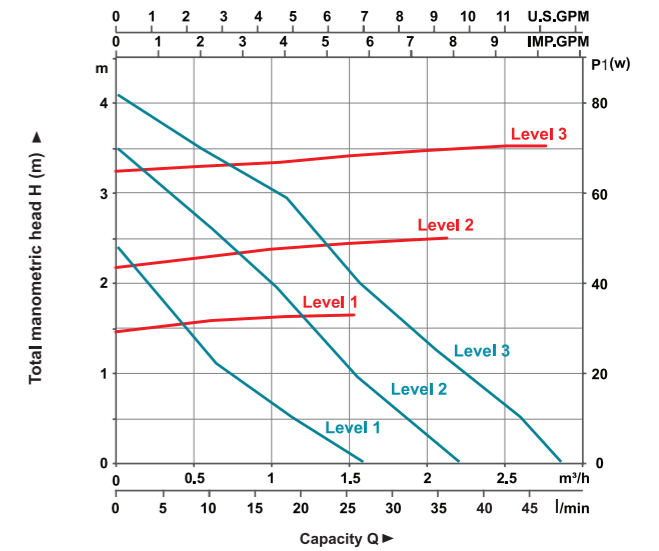

LRP20-40/130
— Q-H
— Q-P

Hydraulic Performance Curves

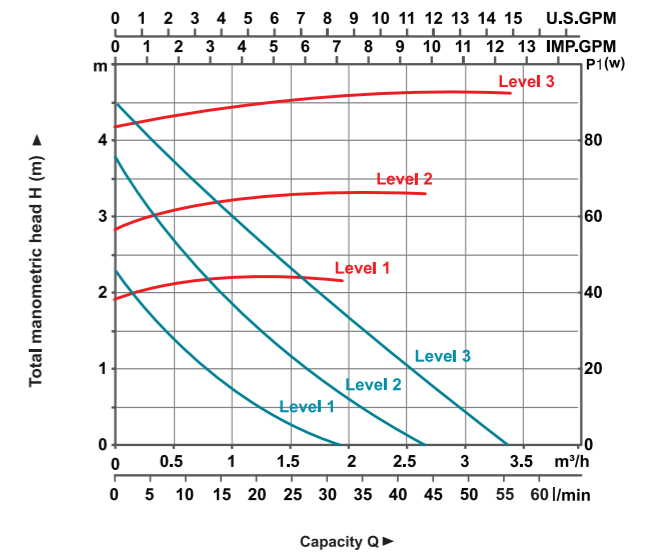
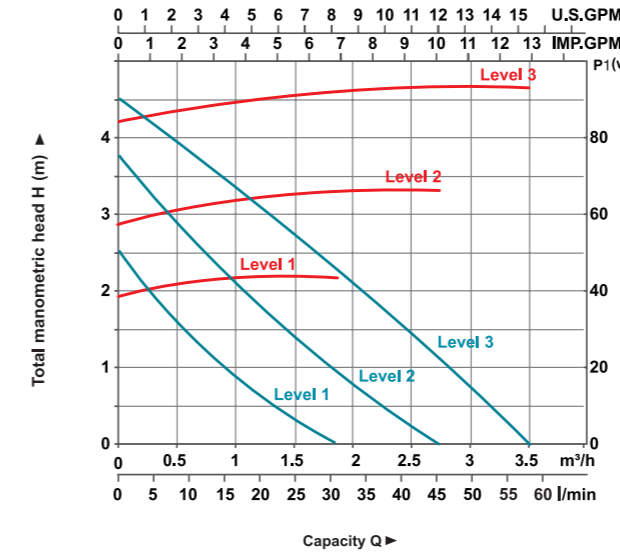
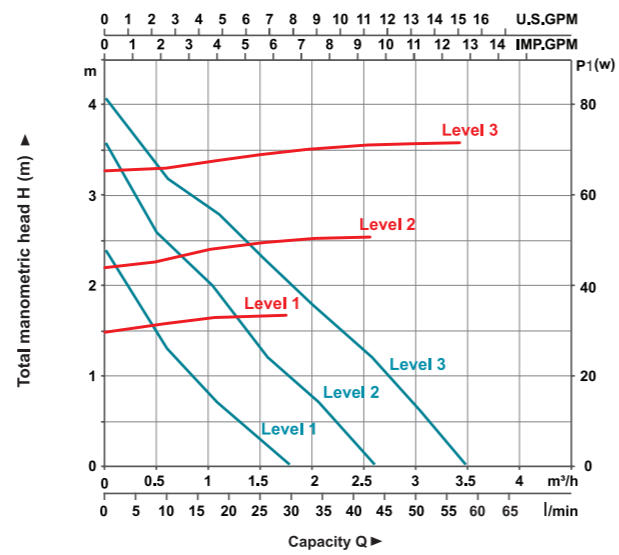
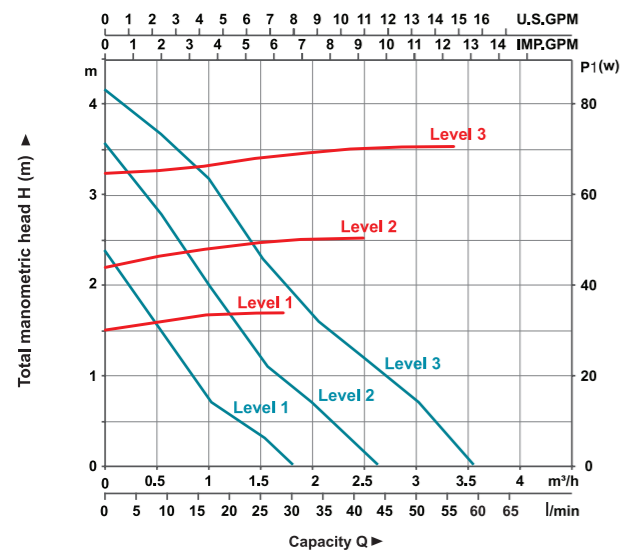
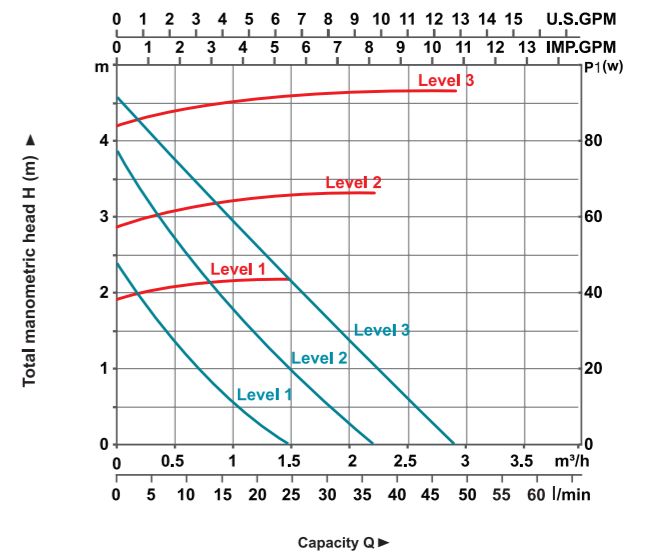
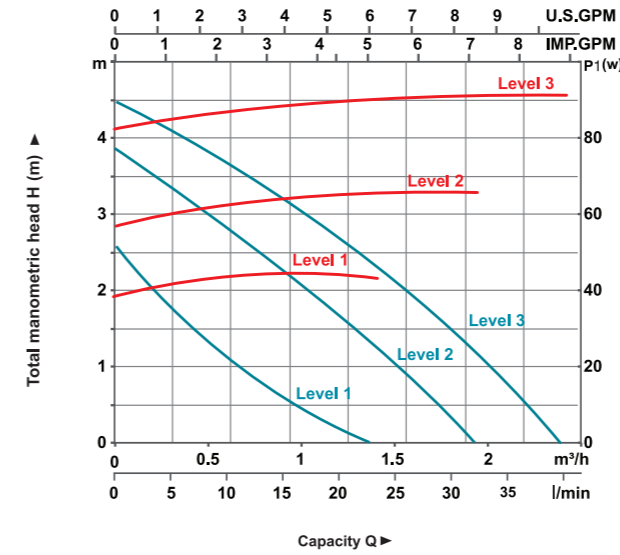
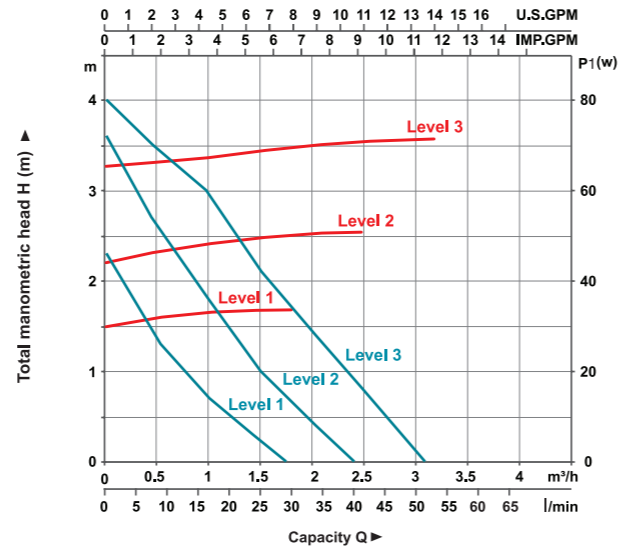
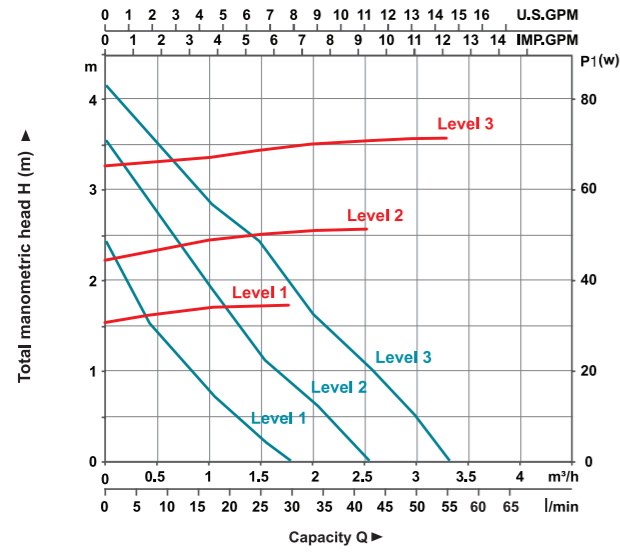

Hydraulic Performance Curves

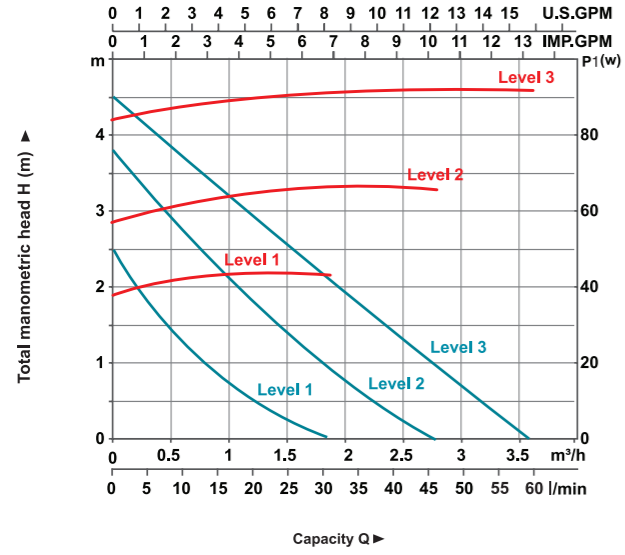

LRP25-50/180
— Q-H
— Q-P

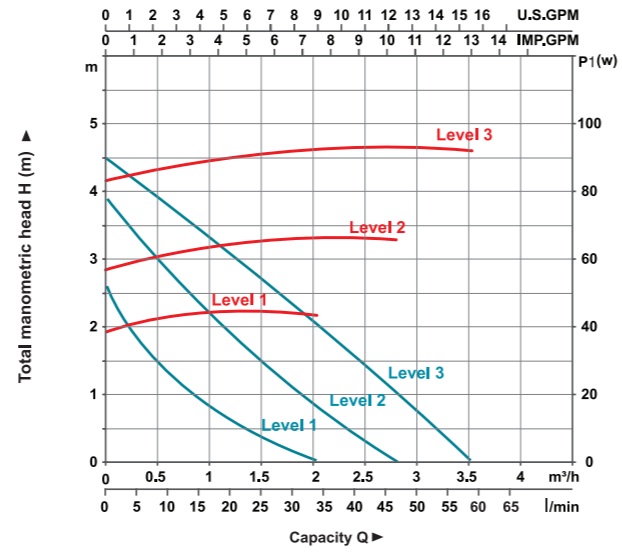

LRP32-50/180
— Q-H
— Q-P

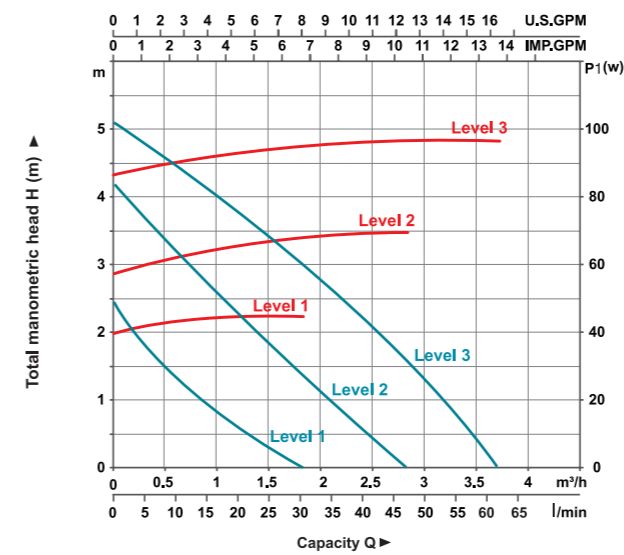

LRP21-60F/120
— Q-H
— Q-P

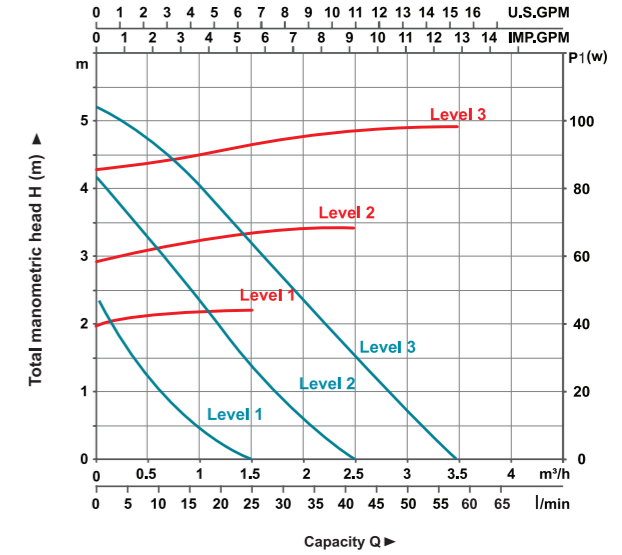

LRP25-60/130
— Q-H
— Q-P

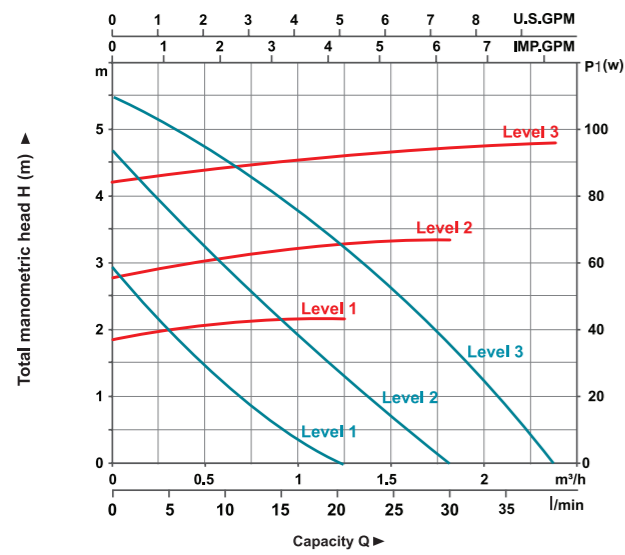

LRP15-60B/130
LRP15-60/130
— Q-H
— Q-P

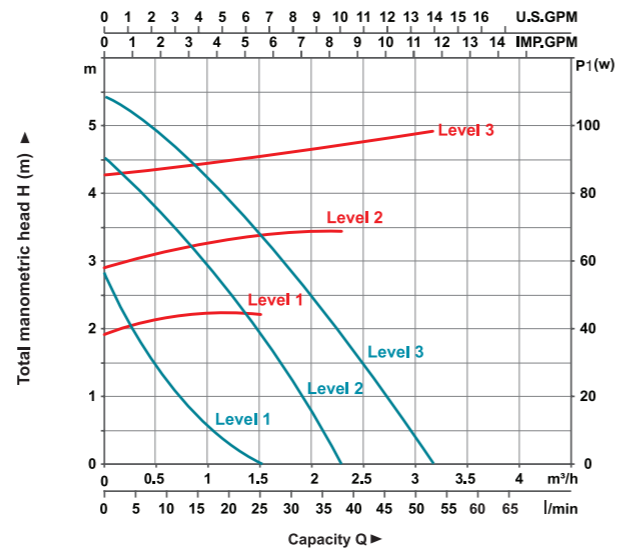

LRP20-60/130
— Q-H
— Q-P

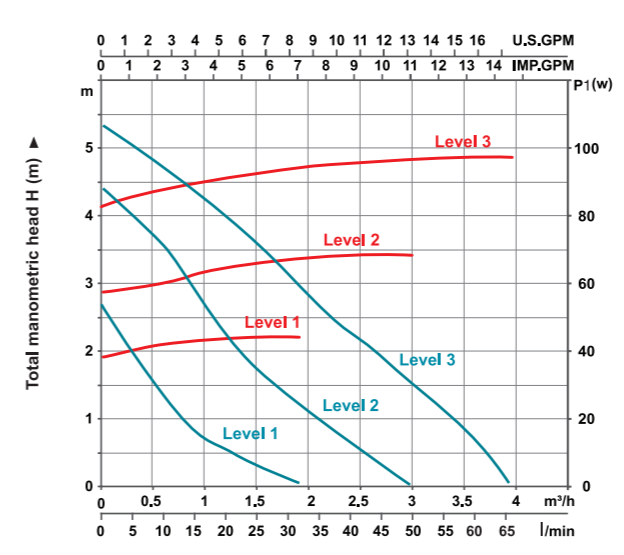

LRP25-60/180
— Q-H
— Q-P

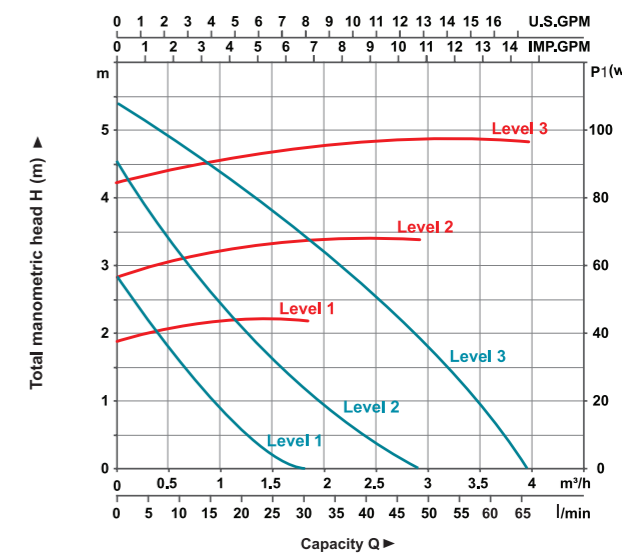

LRP32-60/180
— Q-H
— Q-P

Hydraulic Performance Curves

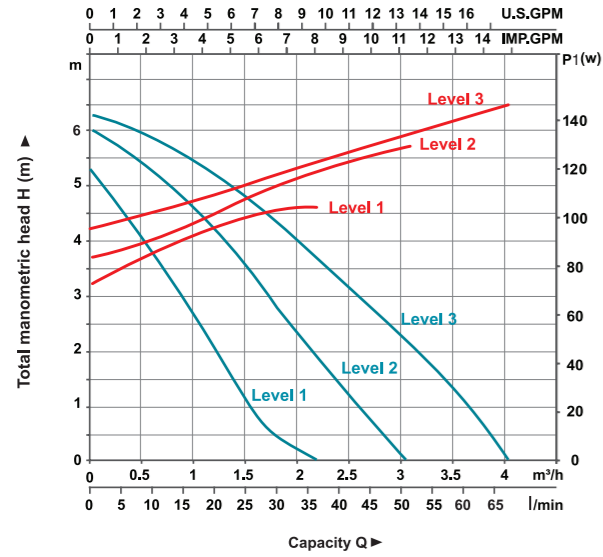

LRP21-70F/120
— Q-H
— Q-P

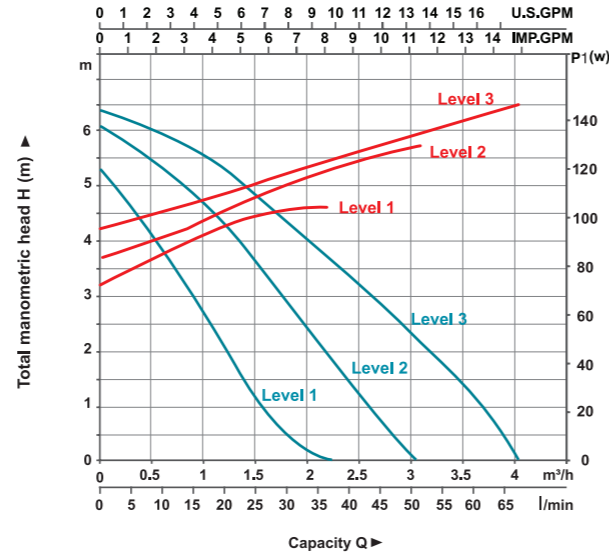

LRP25-70/130
— Q-H
— Q-P

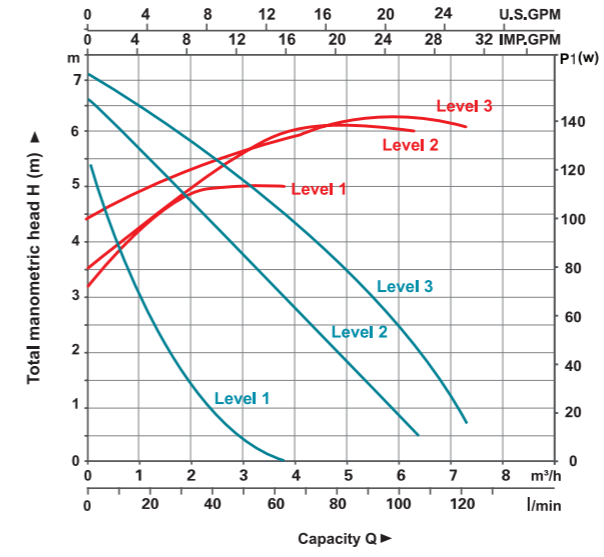

LRP25-80/180
— Q-H
— Q-P

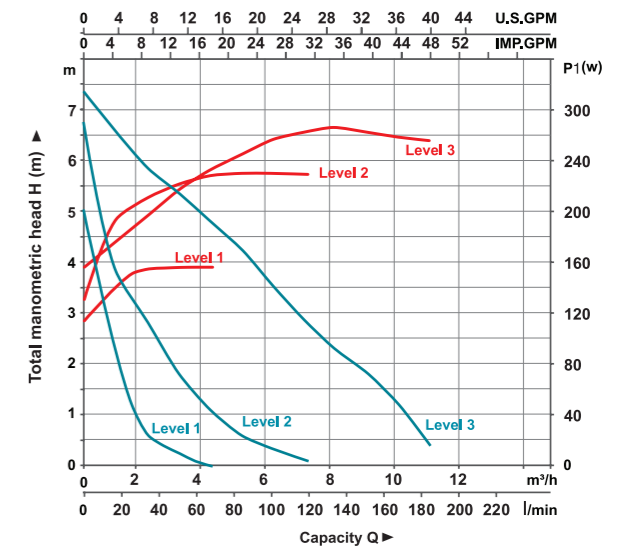

LRP32-80/180
LRP32-80F/220
LRP36-80F/200
LRP40-80F/250
— Q-H
— Q-P

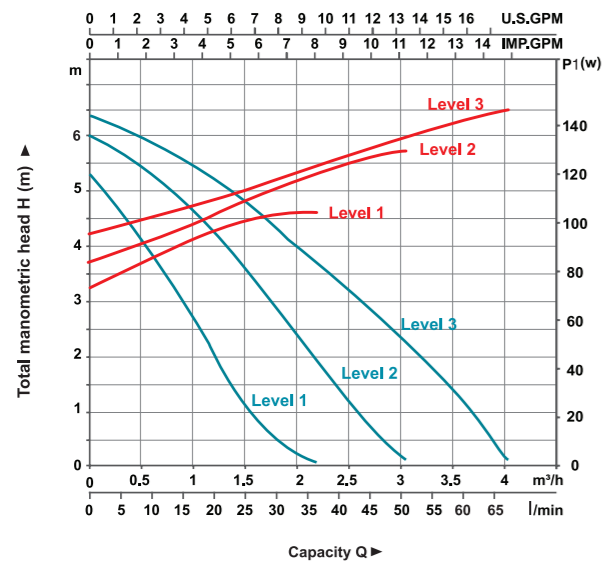

LRP25-70/180
— Q-H
— Q-P

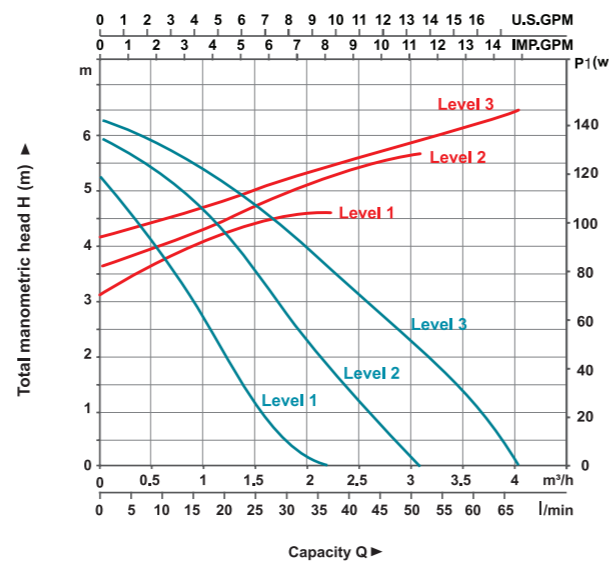

LRP32-70/180
— Q-H
— Q-P

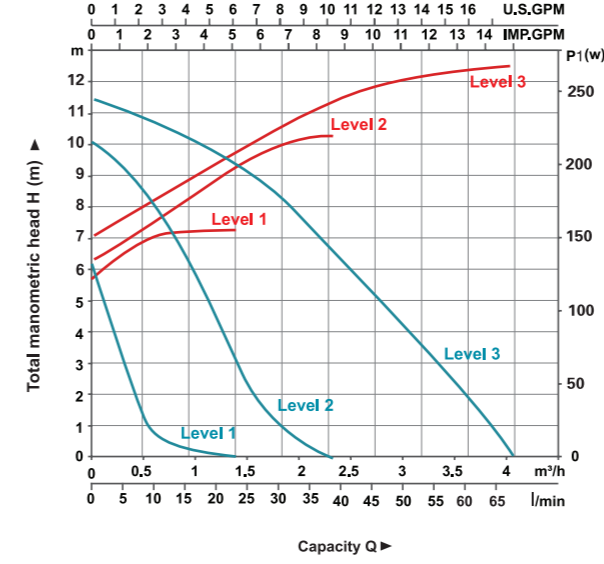

LRP25-120/180
— Q-H
— Q-P